

Energy Conversion by Sorption Processes: Fundamental Options and Challenges

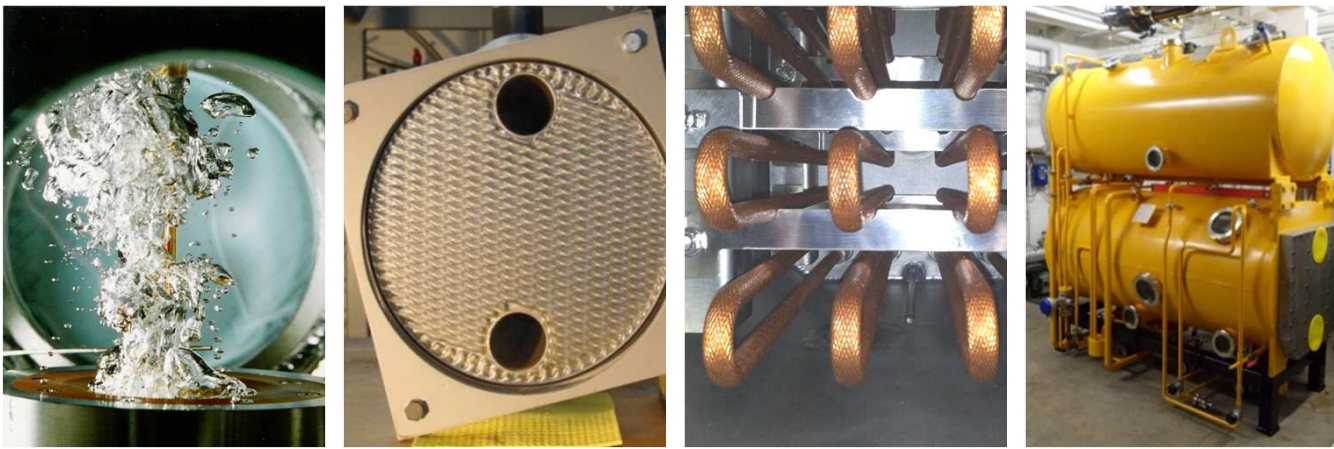

1. New fluids will not bring better COPs.
New fluids may cure problems of today`s fluids.
2. The transport properties are most important.
3. New cycles may bring forth new fields of application.

$$COP = \frac{q_{evap}}{q_{des} + q_{sub}}$$

$$\approx \frac{r}{r+l}$$

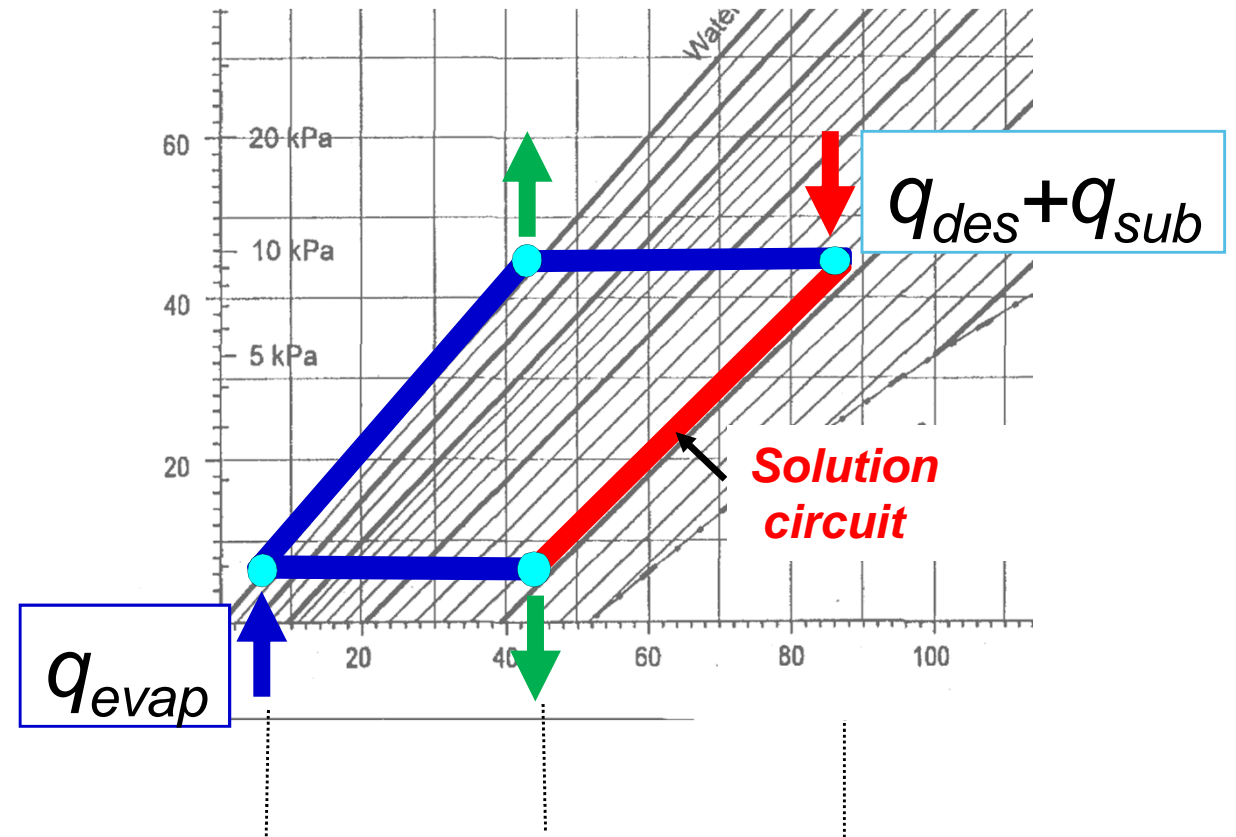

$$COP = \frac{q_{evap}}{q_{des} + q_{sub}}$$

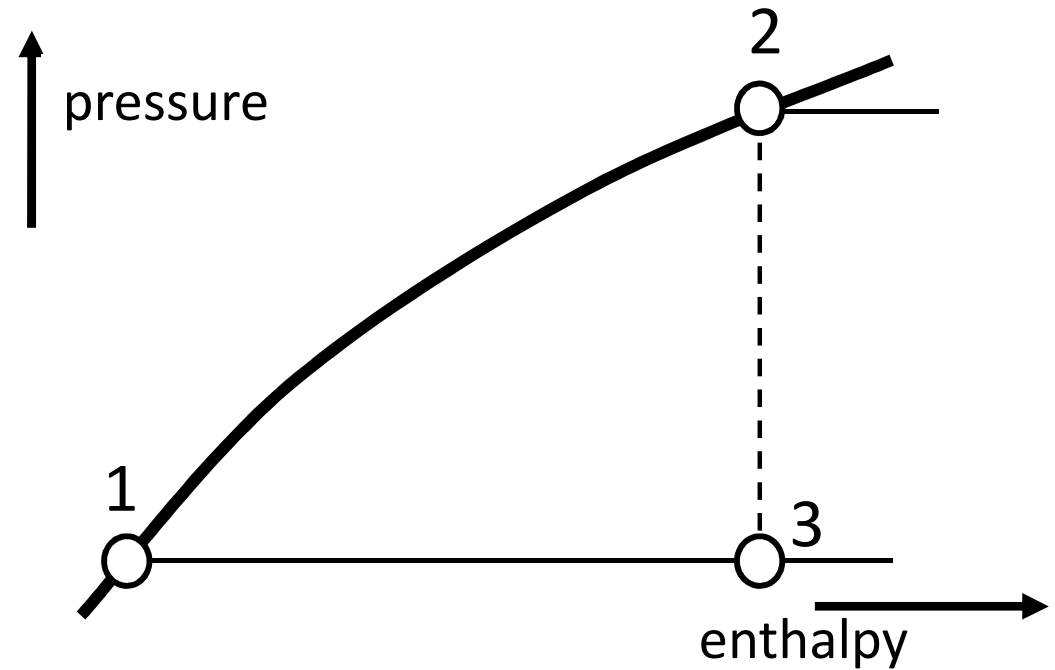

$$q_{evap} = r_0 - (h_2 - h_1) \approx r_0(1 - St_{th})$$

$$St_{th} = \frac{c_l \Delta T_{Lift}}{r_0}$$

r latent heat of vaporisation

$$COP = \frac{q_{evap}}{q_{des} + q_{sub}}$$

$$q_{des} = (r + l)_r + x_r c_p \left. \frac{dT}{dx} \right|_{BL}$$

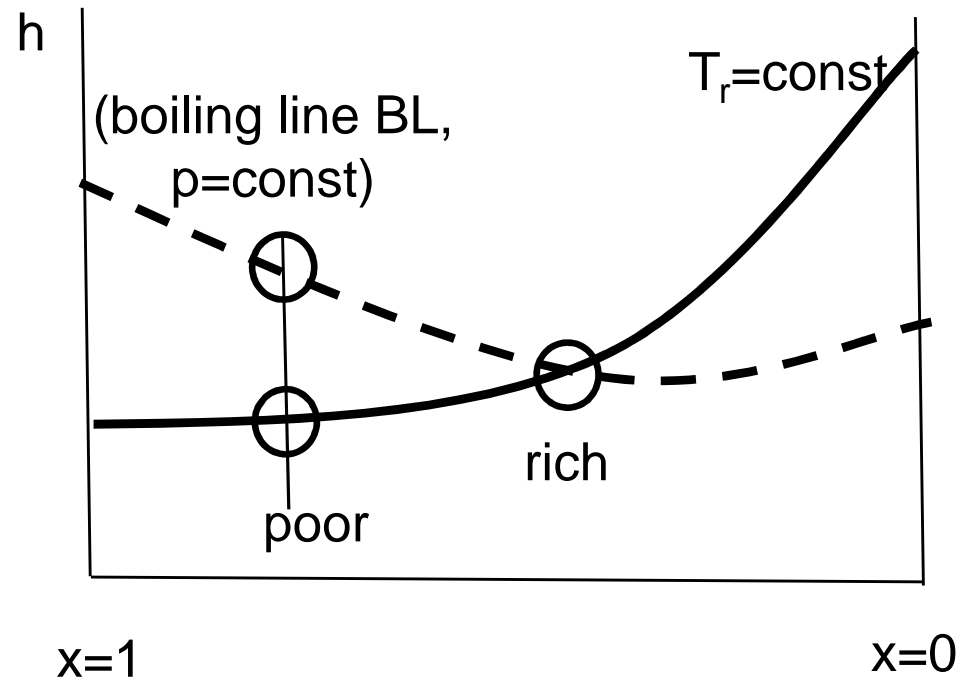
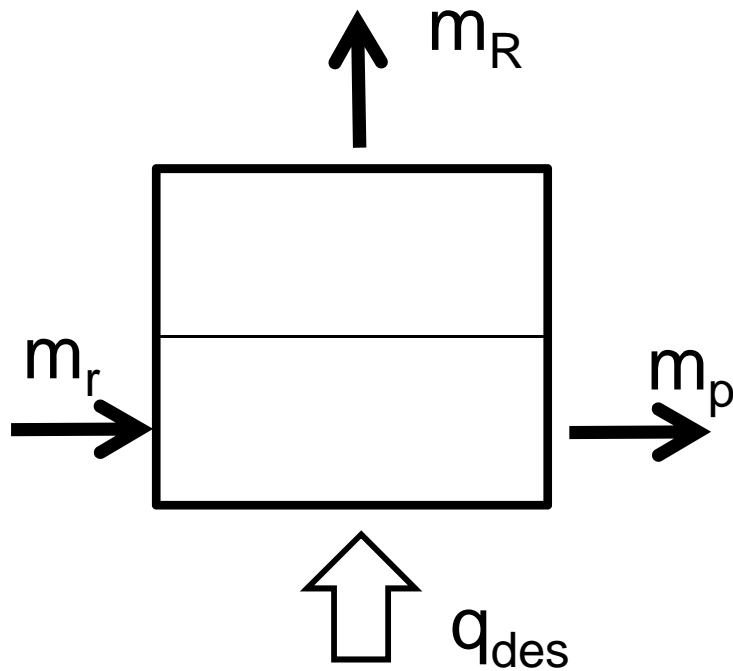

$$\lambda = \frac{l_2}{r_2}$$

Relative differential
heat of solution

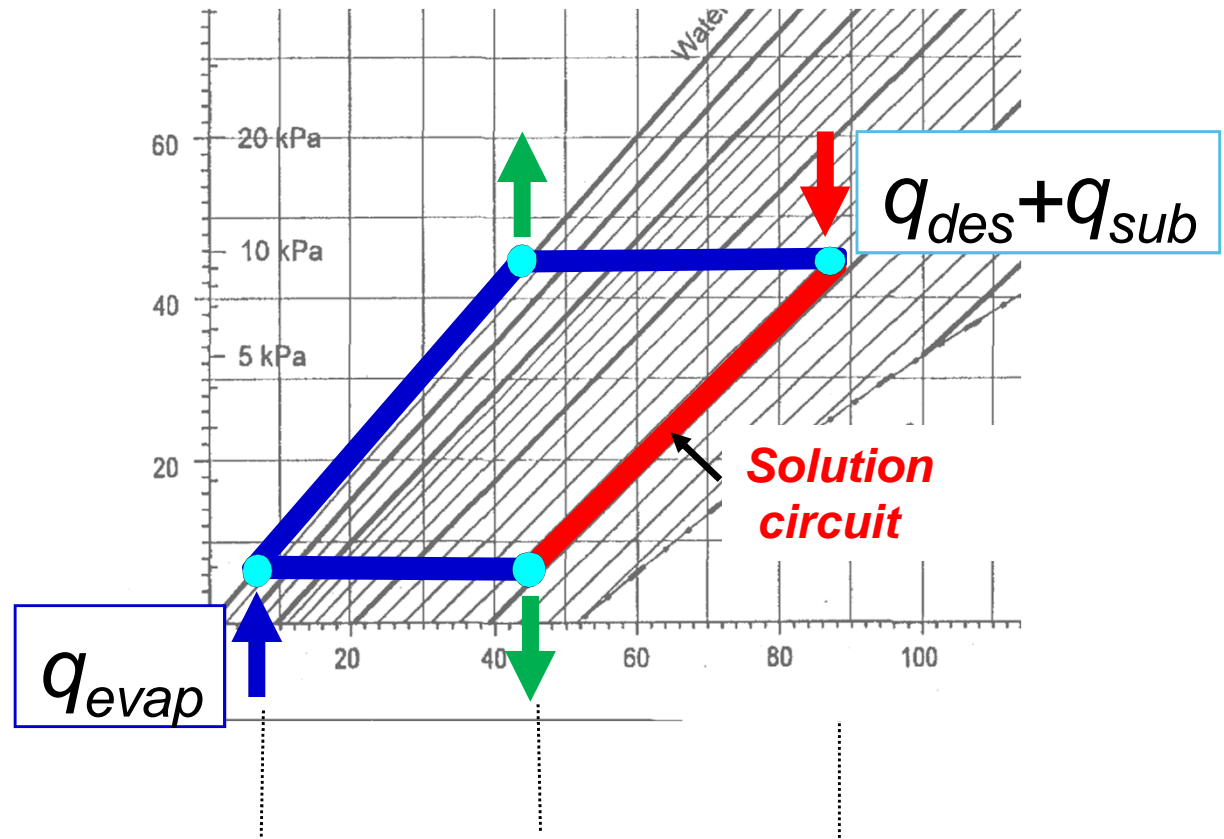

$$COP \approx \frac{r_0 (1 - St_{th})}{r_2 \left(1 + \lambda + f St_{sub} + \frac{x_r}{\Delta T_L} St_p \left. \frac{dT}{dx} \right|_{BL} \right)}$$

$$COP \approx \frac{r_0 (1 - St_{th})}{r_2 \left(1 + \lambda + f St_{sub} + \frac{x_r}{\Delta T_L} St_p \left. \frac{dT}{dx} \right|_{BL} \right)}$$

$$St = \frac{c\Delta T}{r}$$

Stefan-numbers should be small

$$COP \approx \frac{r_0 (1 - St_{th})}{r_2 \left(1 + \lambda + f St_{sub} + \frac{x_r}{\Delta T_L} St_p \left. \frac{dT}{dx} \right|_{BL} \right)}$$

$$\lambda = \frac{l_2}{r_2}$$

Relative differential heat of solution should be small (or negative?)

Clausius-Clapeyron:

$$\frac{d \ln p}{d(-1/T)} \approx \frac{h''_{10} - h'_1}{R}$$

$$\frac{d \ln p}{d(-1/T)} \approx \frac{r+l}{R}$$

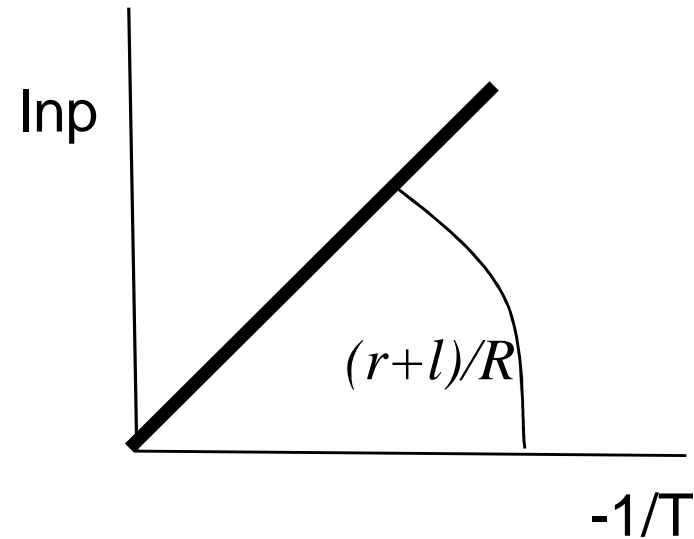

r latent heat of vaporisation

$\lambda = \frac{l}{r}$ relative differential enthalpy of solution

Generator temperature:
„normal“ λ

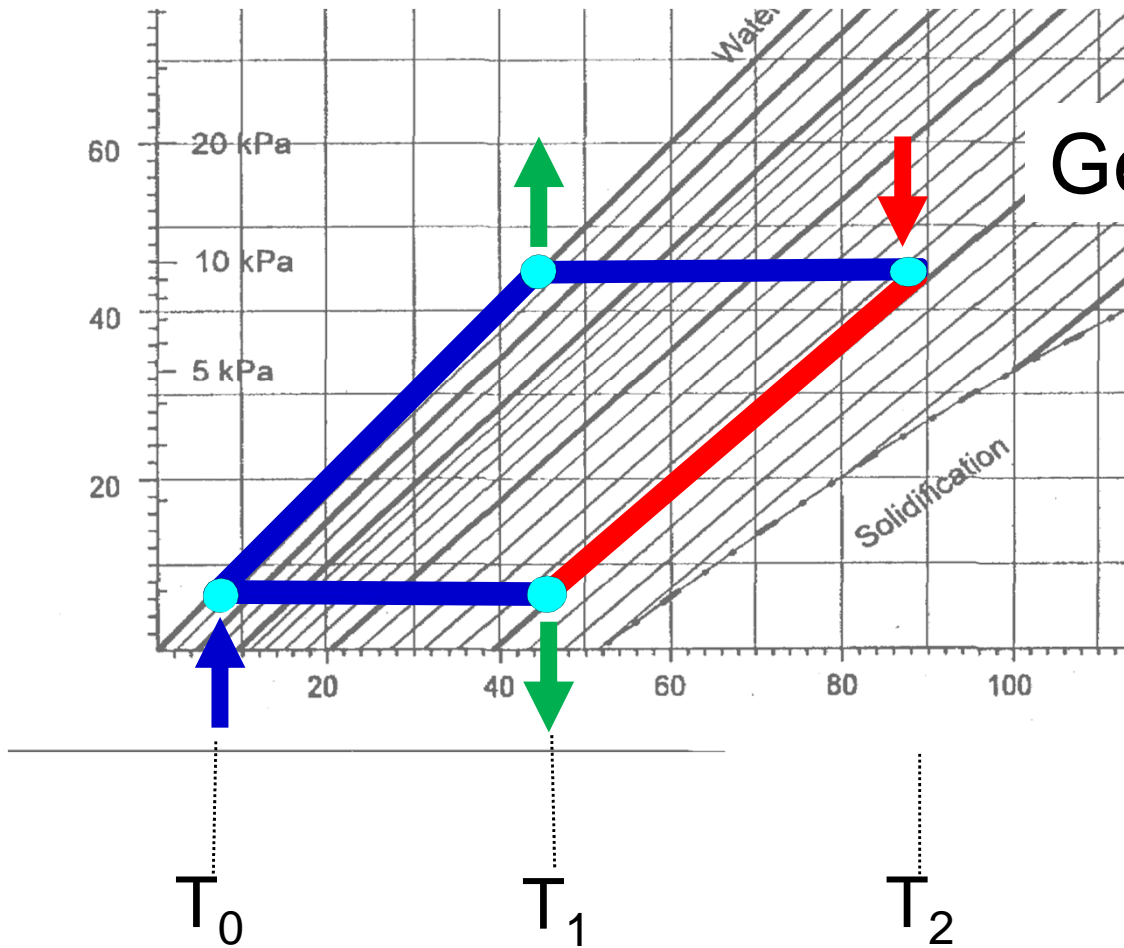

$$(T_2 - T_1) \approx (T_1 - T_0) \left(1 + 2 \frac{T_1 - T_0}{T_1} - \lambda \right)$$

Generator temperature:

Small or negative λ : rising T_G

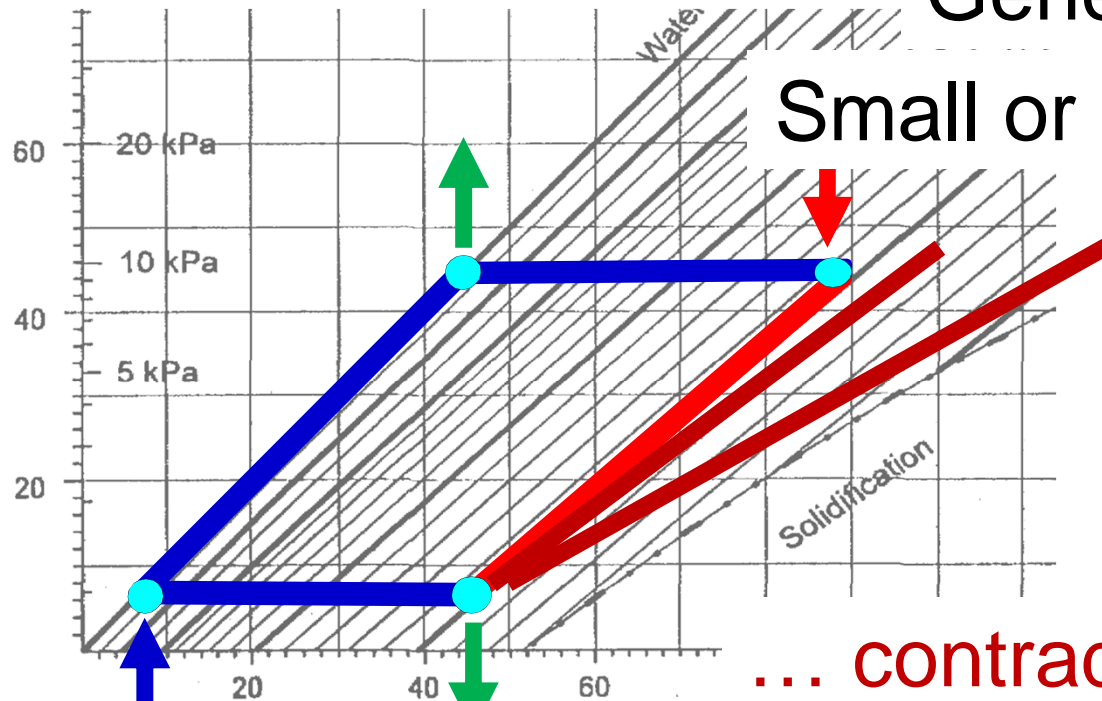

... contradicts Trouton's Rule

T_0

T_1

T_2

$$(T_2 - T_1) \approx (T_1 - T_0) \left(1 + 2 \frac{T_1 - T_0}{T_1} - \lambda \right)$$

$$COP \approx \frac{r_0(1 - St_{th})}{r_2 \left(1 + \lambda + f St_{sub} + \frac{x_r}{\Delta T_L} St_p \left. \frac{dT}{dx} \right|_{BL} \right)}$$

| | |
|-------------------------------------|-------|
| $\frac{x_r}{\Delta T_L}$ | small |
| $\left. \frac{dT}{dx} \right _{BL}$ | large |

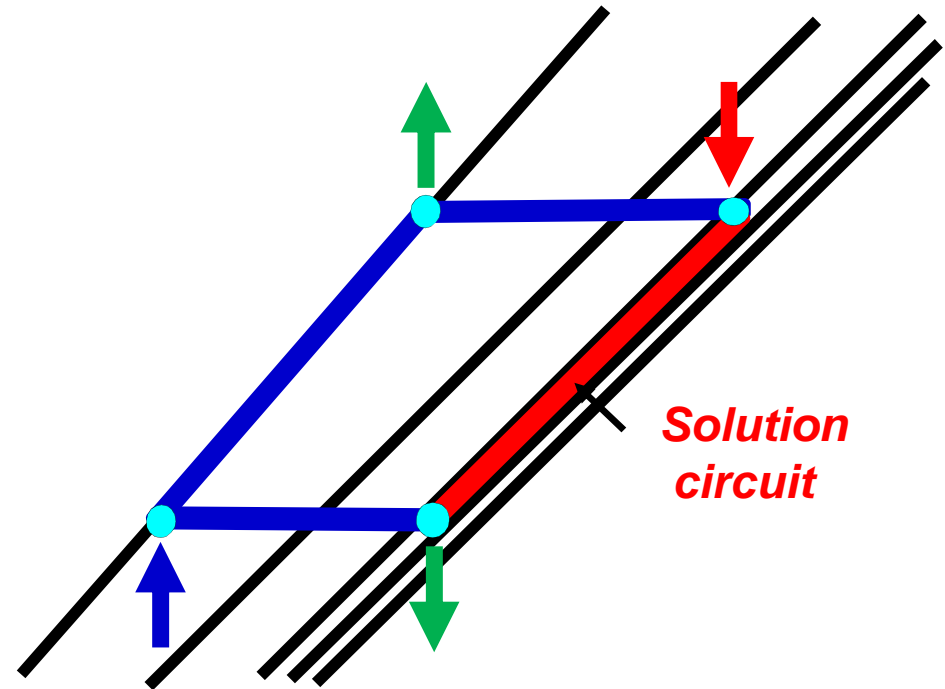
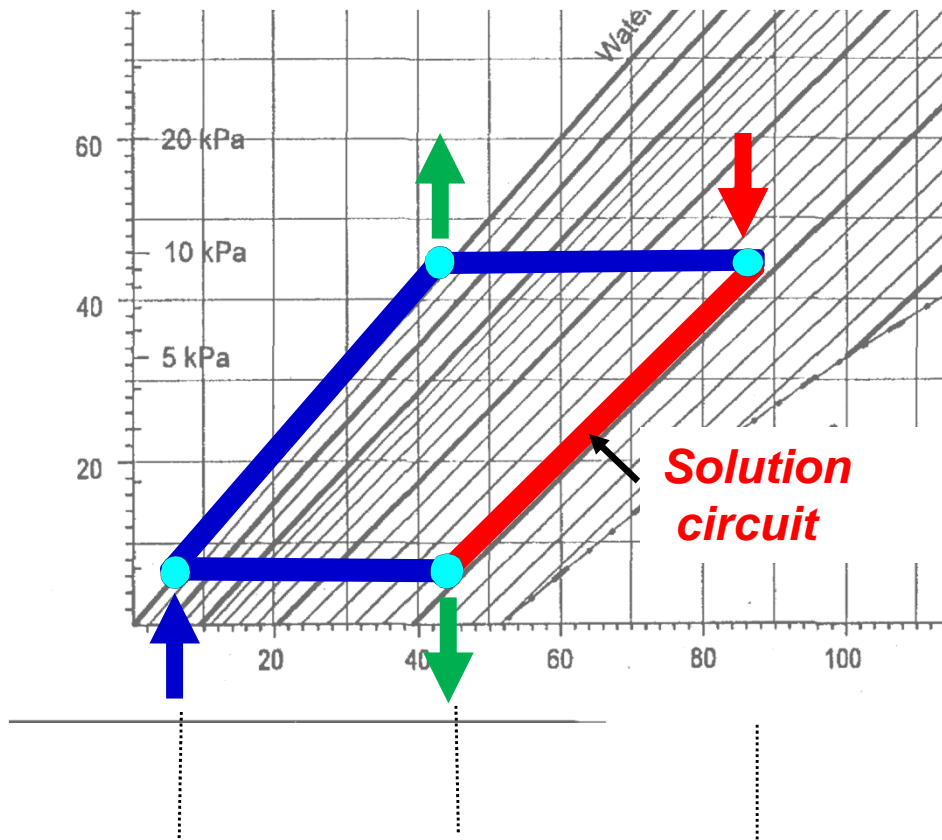

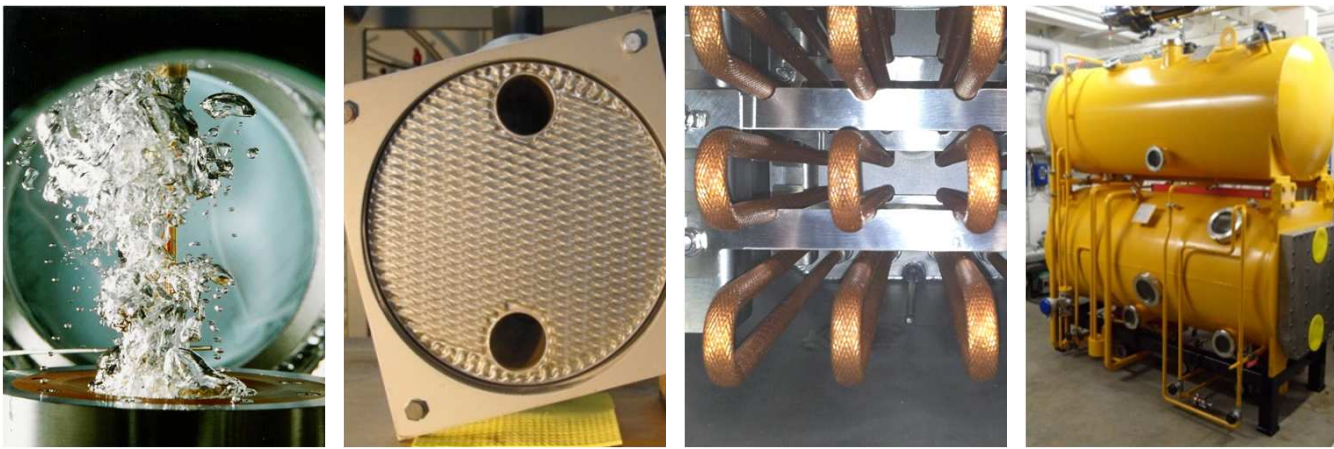

1. New fluids will not bring better COPs.
New fluids may cure problems of today`s fluids.
- 2. The transport properties are most important.**
3. New cycles may bring forth new fields of application.

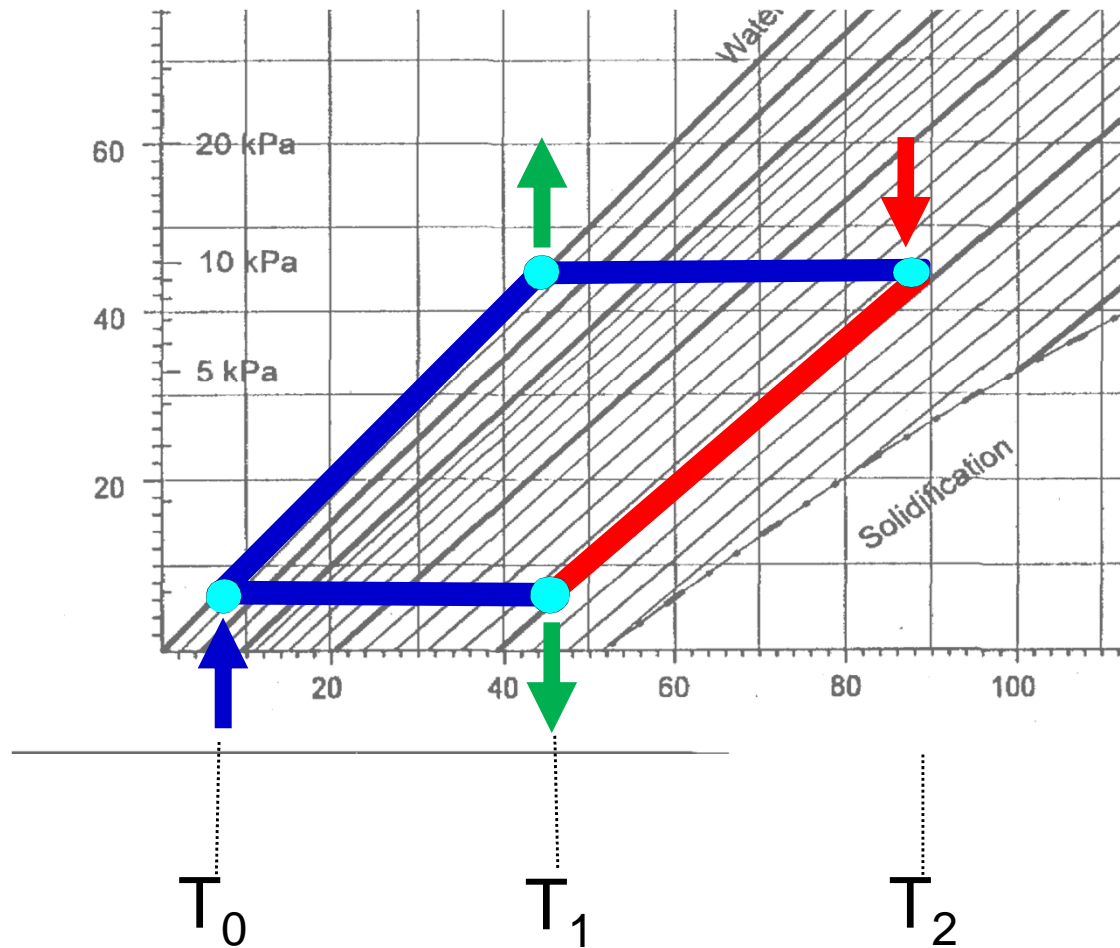

$$(T_2 - T_1) \approx (T_1 - T_0) \left(1 + 2 \frac{T_1 - T_0}{T_1} - \lambda \right)$$

Heat transfer across each main component:

$$\dot{Q}_X = (UA)_X |T_X - t_X|$$

„internal“
(working pair)

„external“
(application)

$$\dot{Q}_X = \left(\begin{matrix} U \\ A \end{matrix} \right)_X \Delta T$$

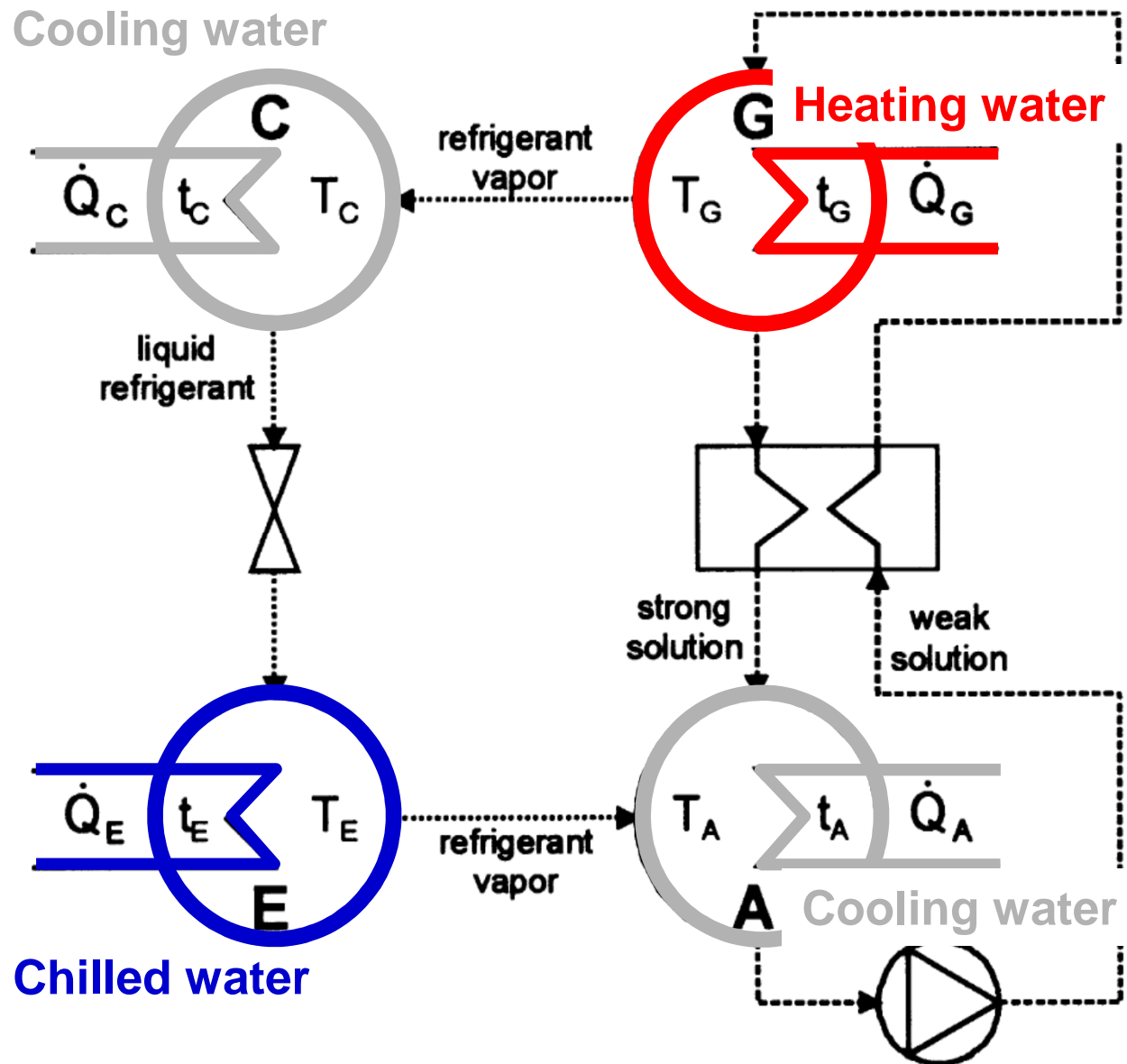

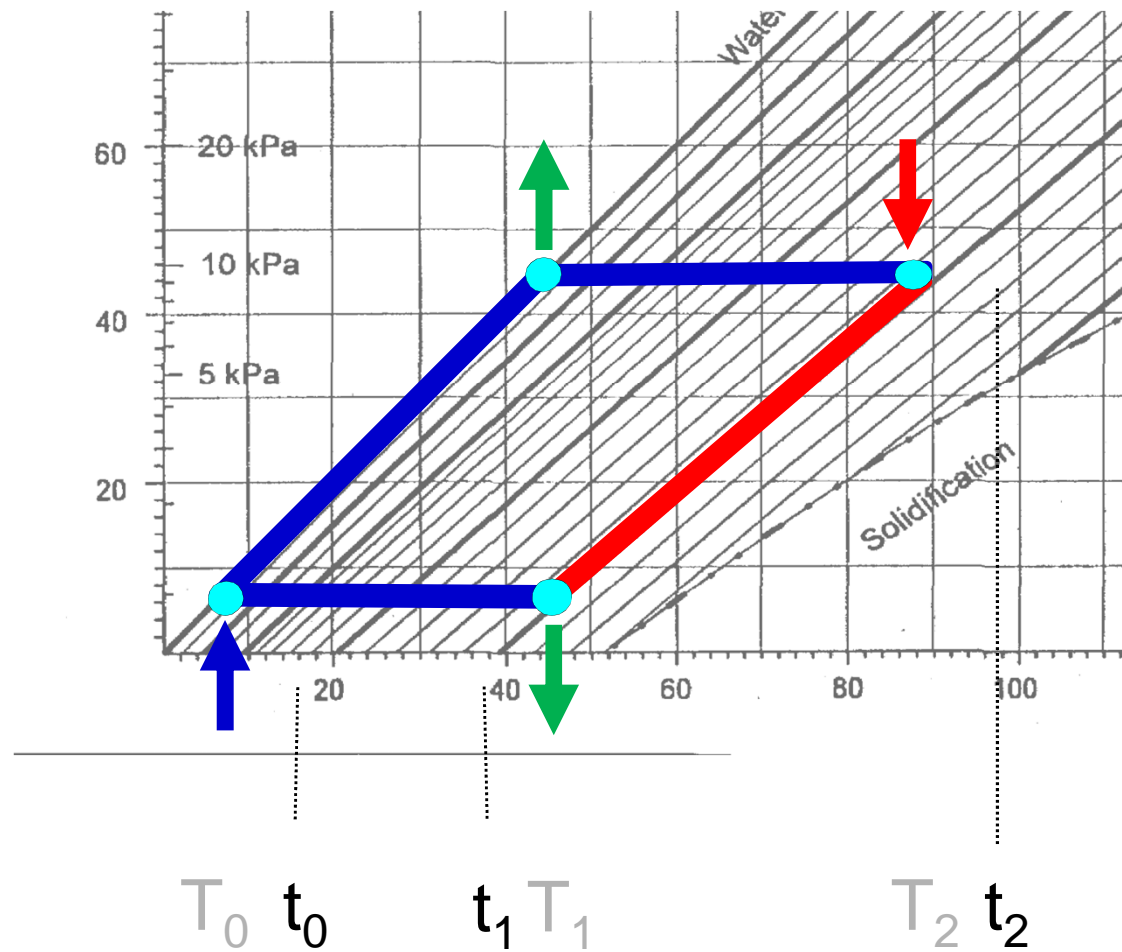

ΔT is more important than λ !

Determined by transport properties

$$(t_2 - t_1) \approx (t_1 - t_0 + 2\Delta T) \left(1 - \lambda + 2 \left(\frac{t_1 - t_0}{t_1} + \frac{2\Delta T}{t_1} \right) \right) + 2\Delta T$$

$$(t_2 - t_1) > (t_1 - t_0 + 4\Delta T)$$

Heat transfer across each main component:

$$\dot{Q}_X = (UA)_X |T_X - t_X|$$

„internal“
(working pair)

„external“
(application)

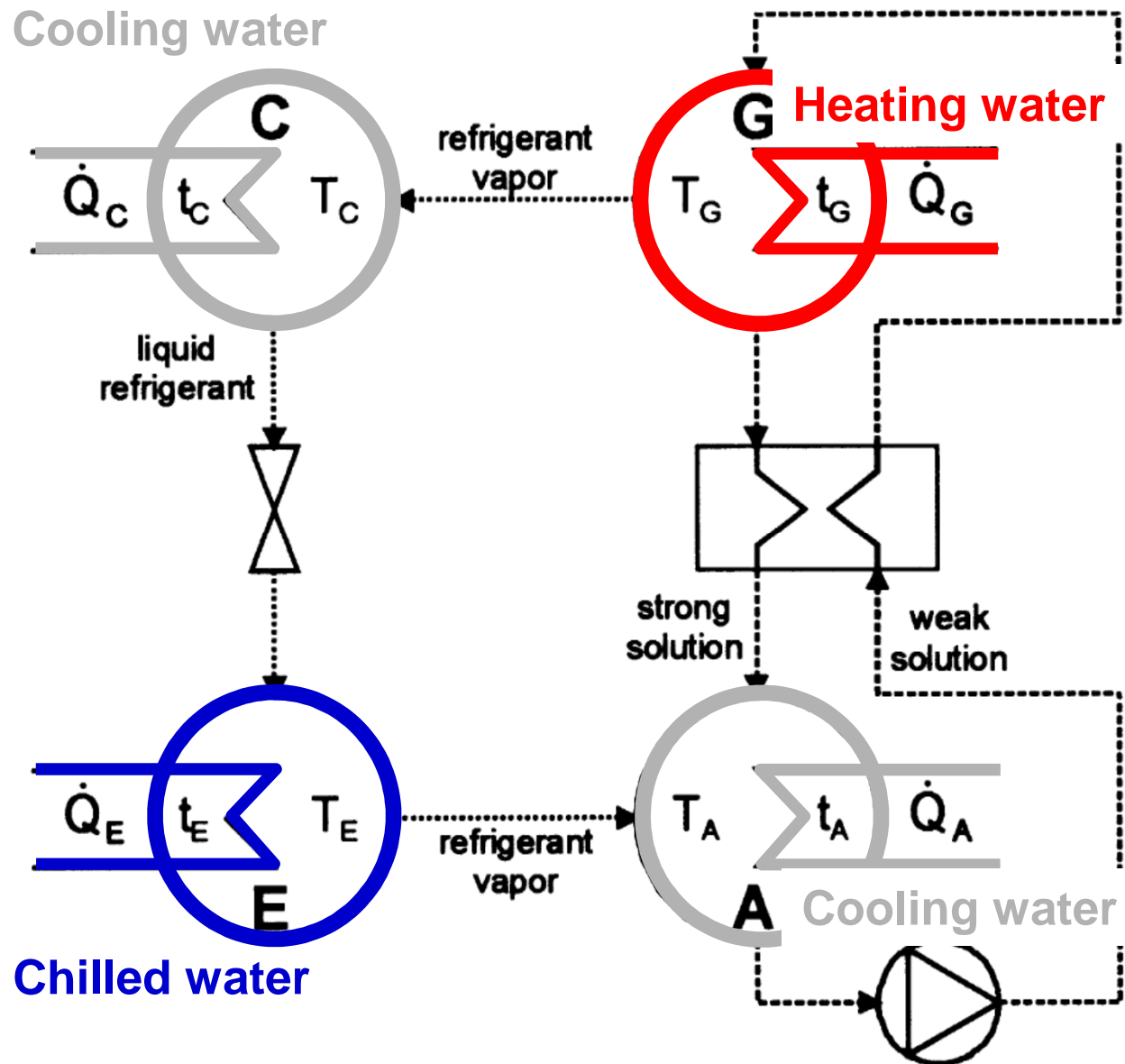

Small changes in temperatures
impact strongly on power density!

Characteristic (external)
temperature difference

$$\Delta\Delta t = a_0 - b_1 + c_2$$

a, b, c from equilibrium properties;
not very variable

specific cooling power [W/€] $q_0 = s_0 + m_0 \Delta\Delta t$

specific heat input [W/€] $q_2 = s_2 + m_2 \Delta\Delta t$

$$\text{COP} = \frac{q_0}{q_2} = \frac{s_0 + m_0 \Delta\Delta t}{s_2 + m_2 \Delta\Delta t}$$

s and m from specific cost and heat transfer
(viscosity, density, wettability, diffusivity...);
very variable!

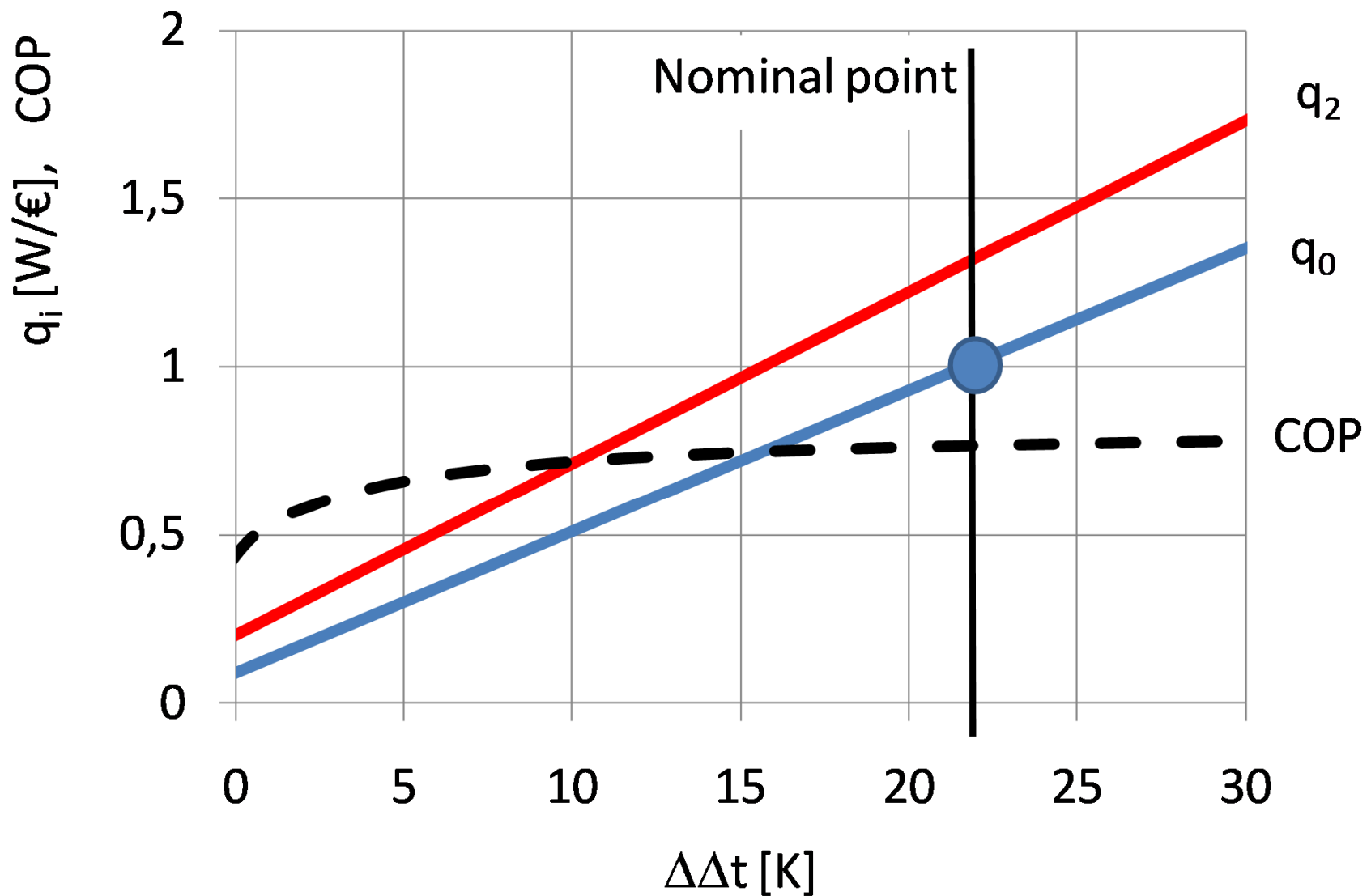

Sorption machines are cheap if:
 t_0 is high; t_1 is low, t_2 is high
 Heat and mass transfer is good

$$\Delta\Delta t = a_0 - b_1 + c_2$$

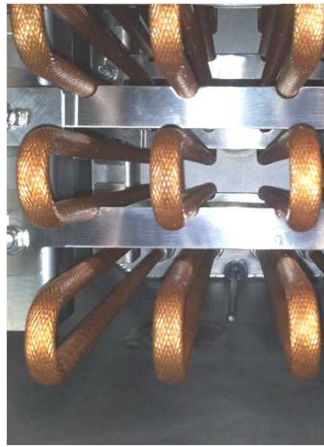
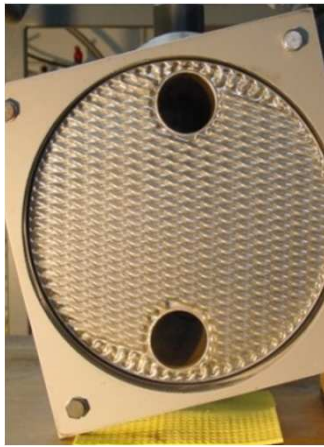

1. New fluids will not bring better COPs.
New fluids may cure problems of today`s fluids.
2. The transport properties are most important.
3. New cycles may bring forth new fields of application.

Multistage cycles are combinations of elementary cycles.

They are used to ...

... increase the COP

e.g.: double-effect

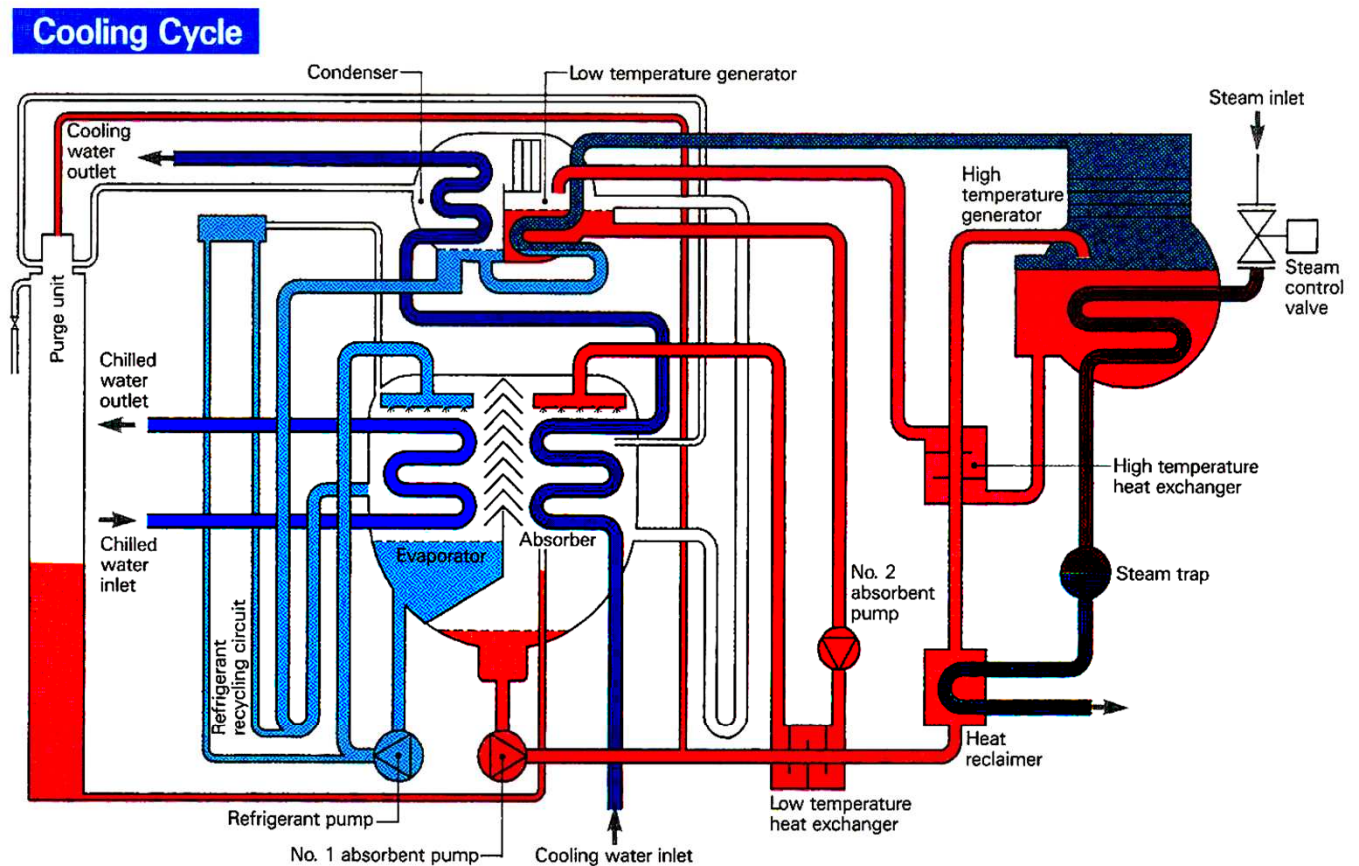
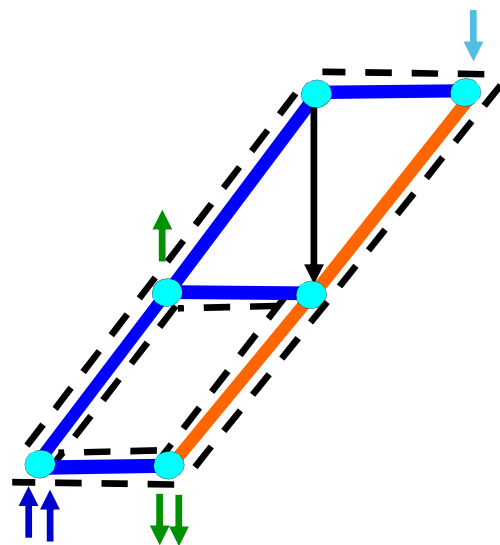

Note: No. 2 absorbent pump is provided on models NC-23 to NC-83 only.

| | | | | | |
|--|-------------------|--|-----------------------|--|-----------------------|
| | Diluted Solution | | Intermediate Solution | | Concentrated Solution |
| | Refrigerant | | Chilled Water | | Cooling Water |
| | Refrigerant Vapor | | Steam Drain | | Steam |

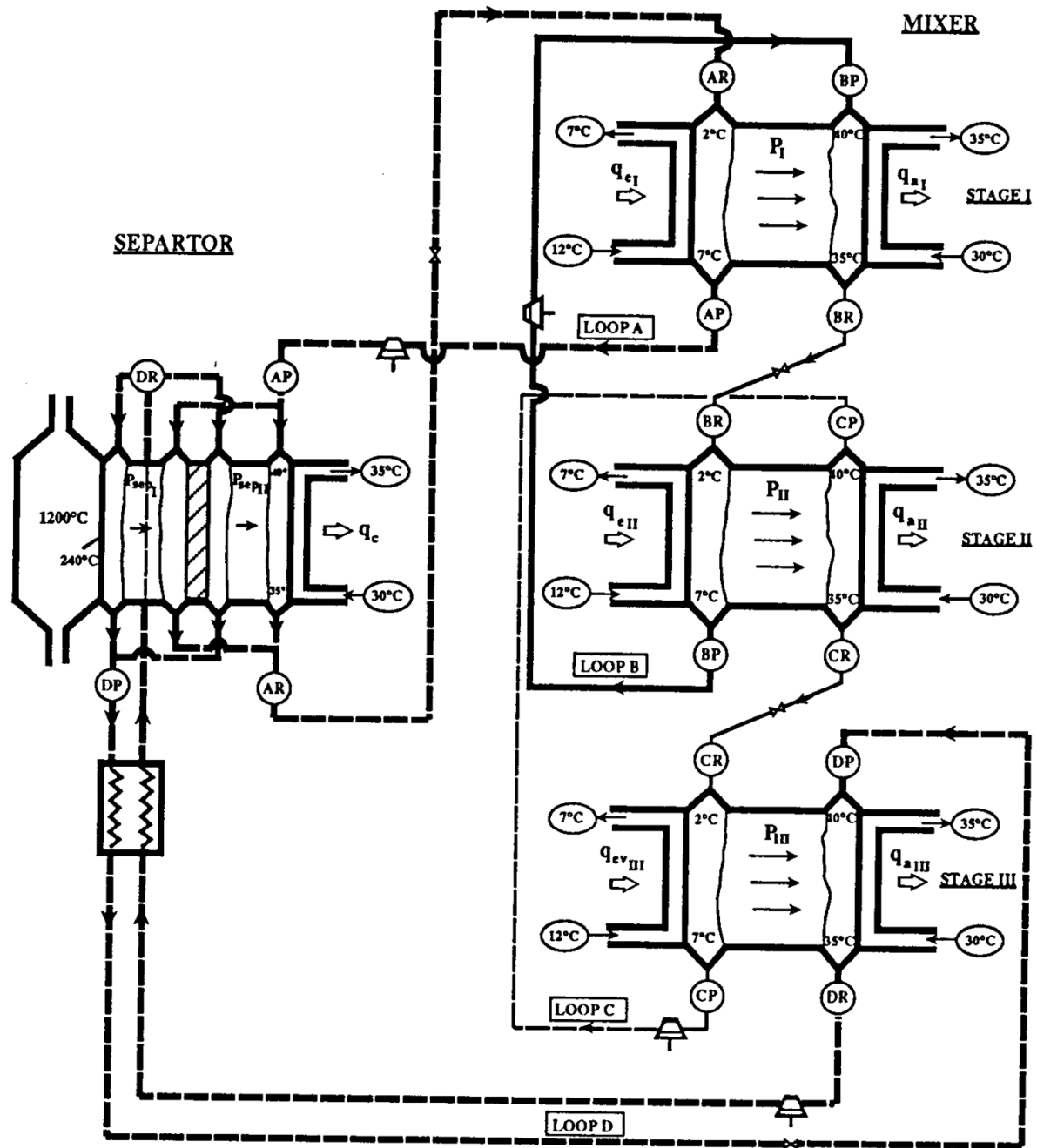
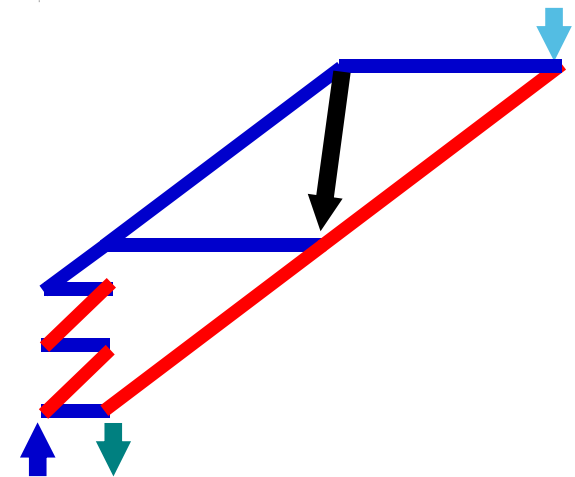
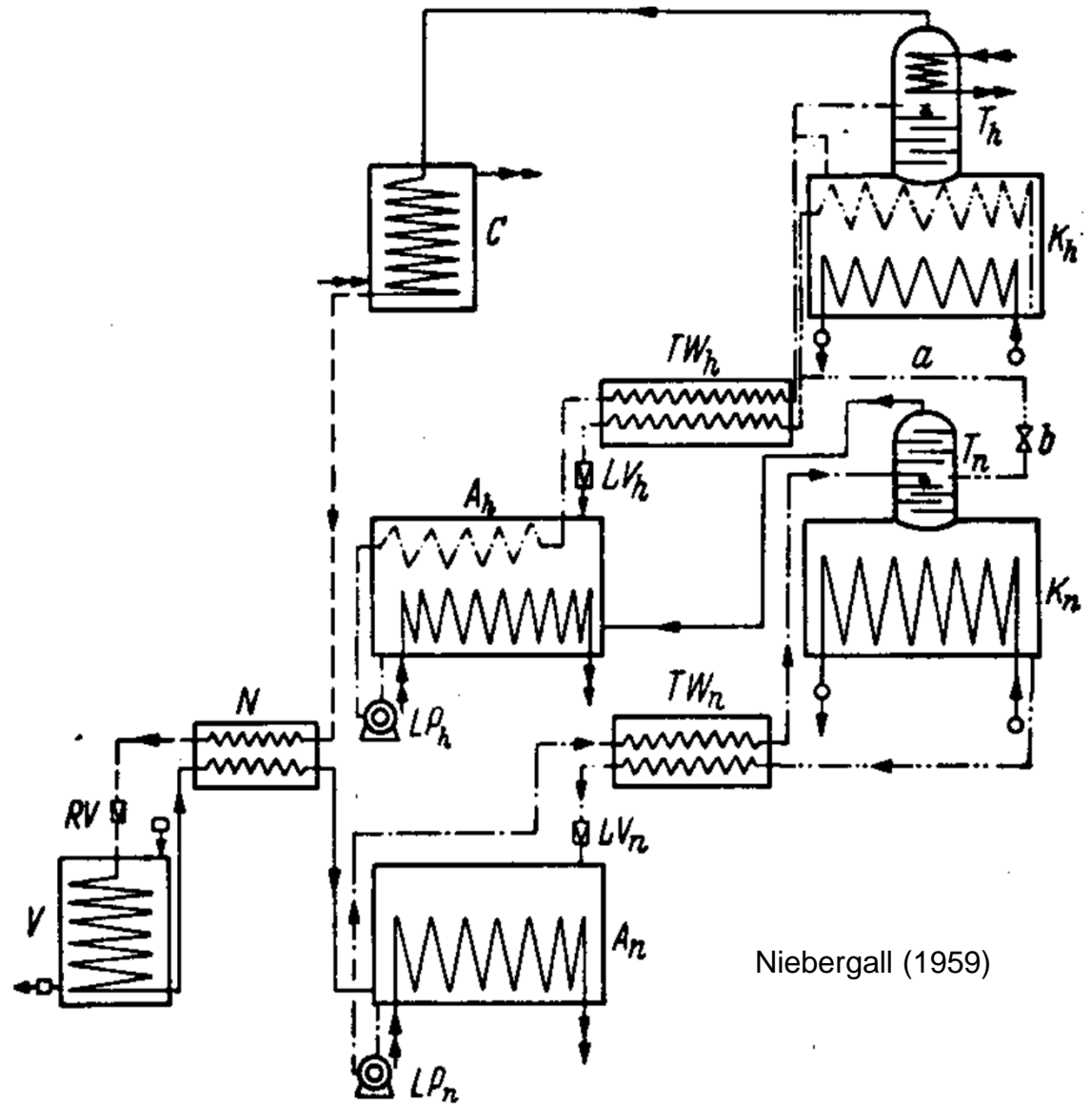
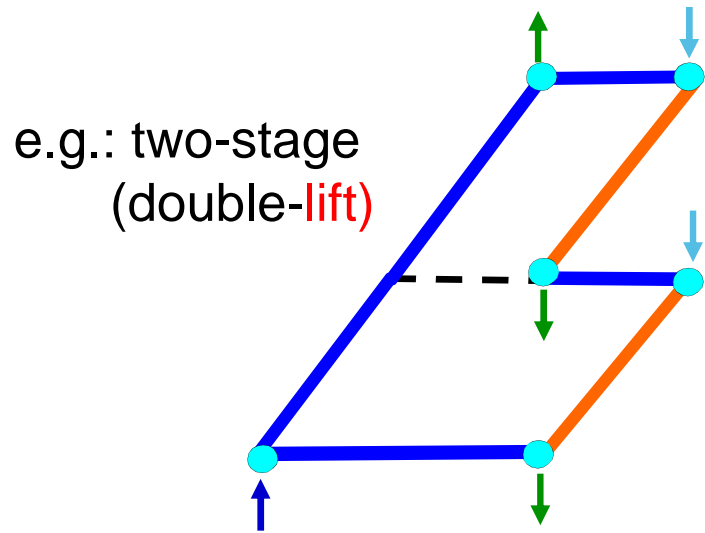

Figure 2: Working principle of multi-stage absorption heat pump



6-effect chiller (Le Goff, 1994)

... or
to increase the temperature lift



Niebergall (1959)

Abb. 26. Schaltbild einer zweistufigen Absorptions-Kälteanlage für Tiefkühlung gemäß Abb. 25.

Heat transformer (Templifier, heat pump type II)

Special: heat from the cold sea (Pierre LeGoff, ~1980)

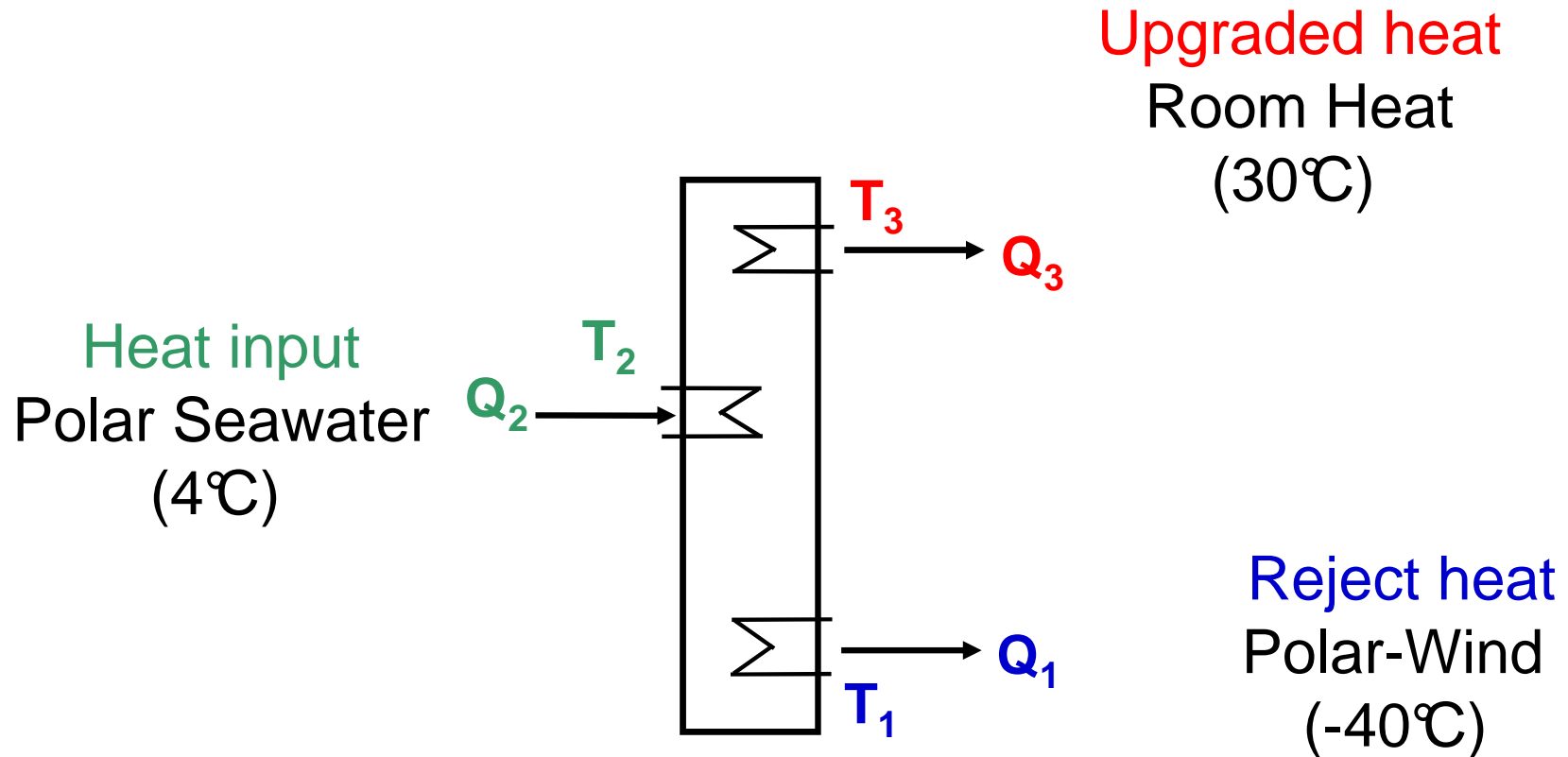

compression-absorption hybrid:
 First practical proposition by Osenbrück (1895):



Abb. 40. Einschaltung eines Vorschaltkompressors (Booster) in eine Absorptions-Kälteanlage.
 A Absorber; B Booster; F Ammoniakflüssigkeitskühler und Ölabscheider; S Abscheider; V Verdampfer. a Ammoniak Eintritt, b Kühlschlange für flüssiges Ammoniak; c Öl ablaß; d Absperrventil; e Kühlwasserzulauf für den Absorber; s_1 und s_2 Flüssigkeitsschwimmerventil.

Niebergall (1959)

„Honigmann“ cycle: storage and conversion of low-grade heat

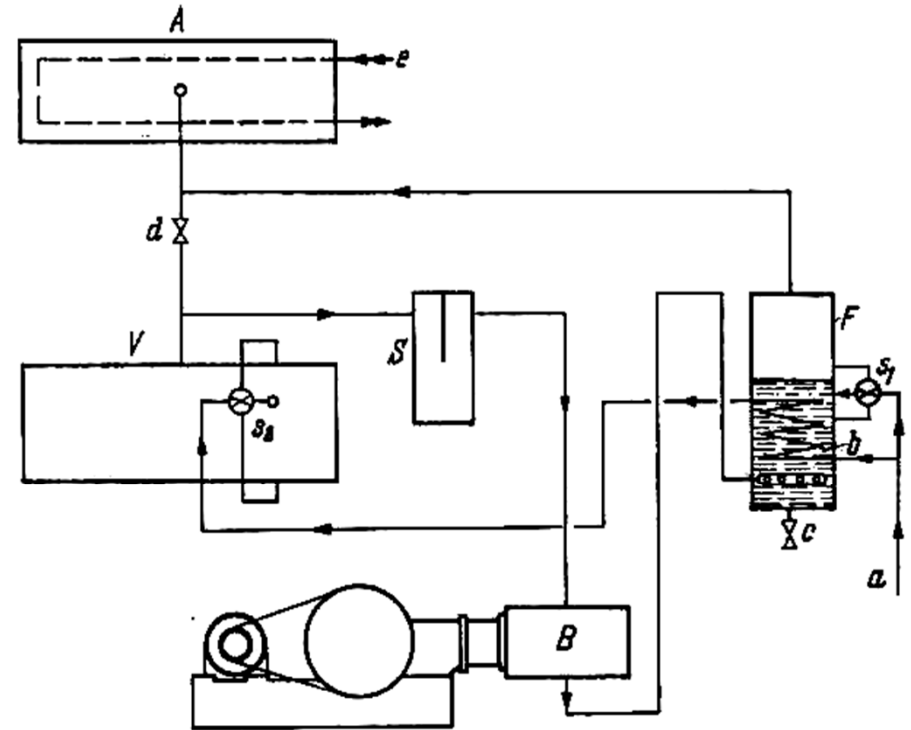
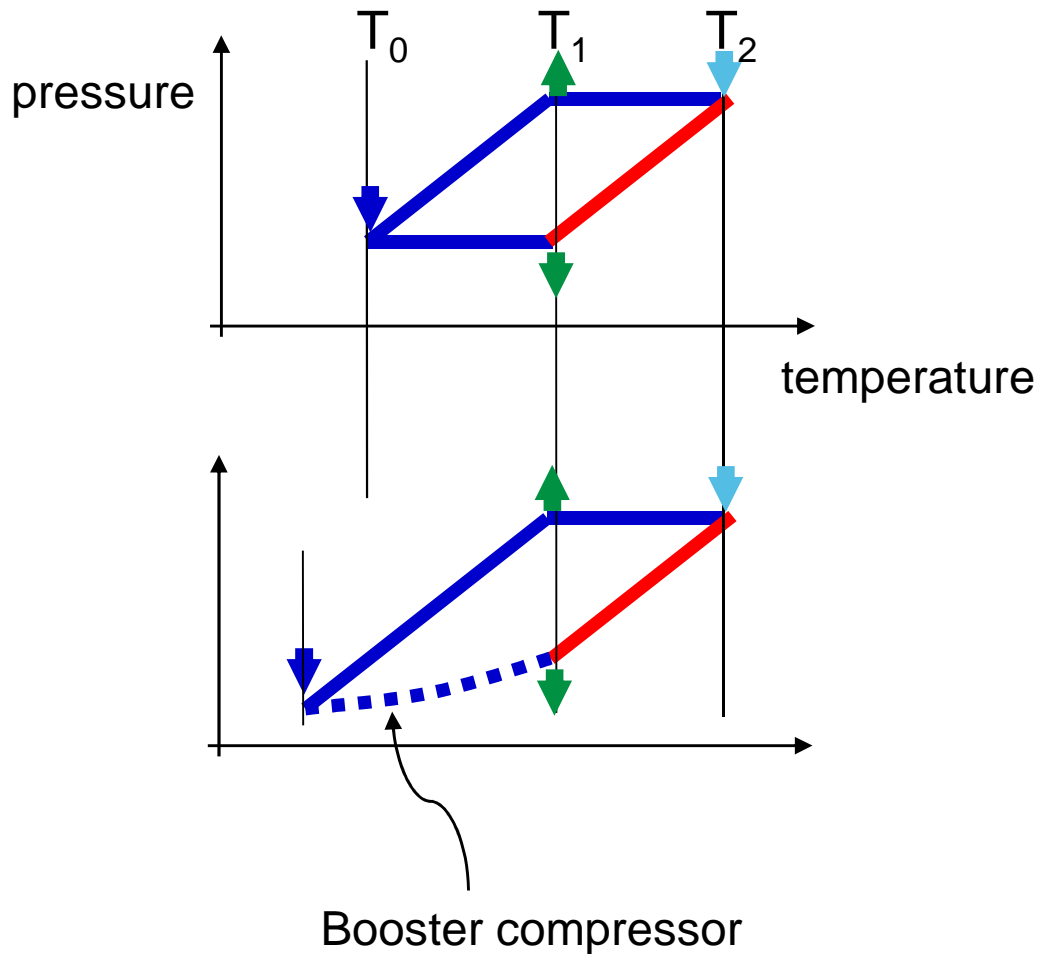

Quelle: Mähr, Vergessene Erfindungen

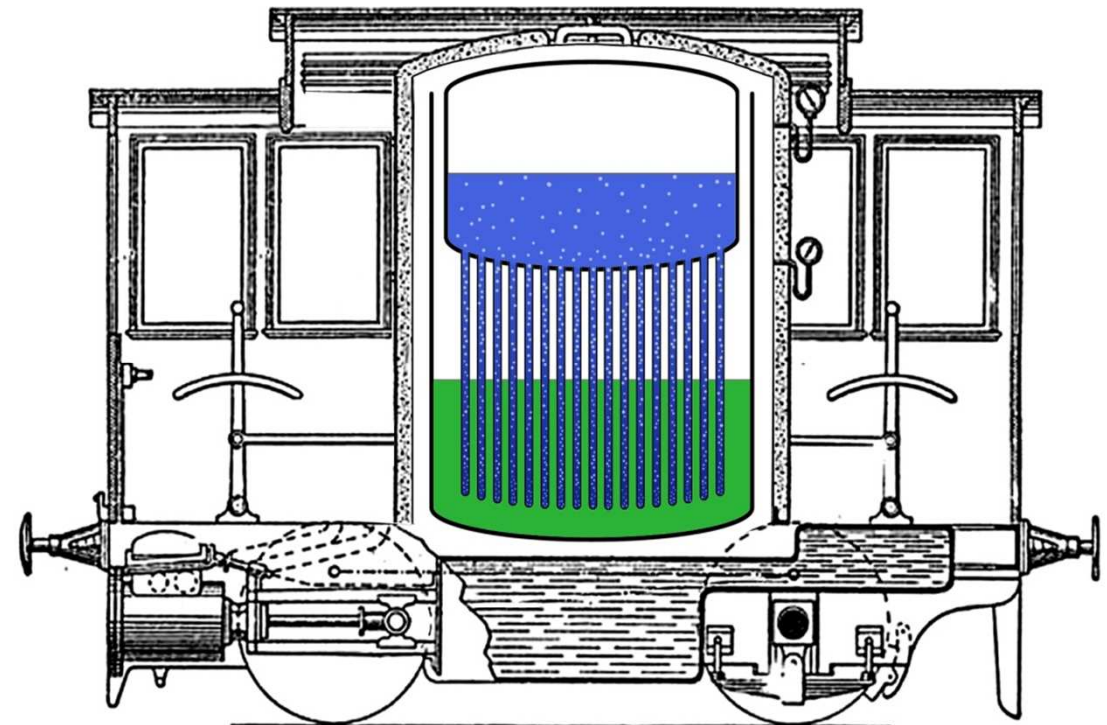

Honigmanns Natronlokomotive. Längsschnitt.

Honigmann fireless locomotive (1883)

„Honigmann“ cycle: storage and conversion of low-grade heat

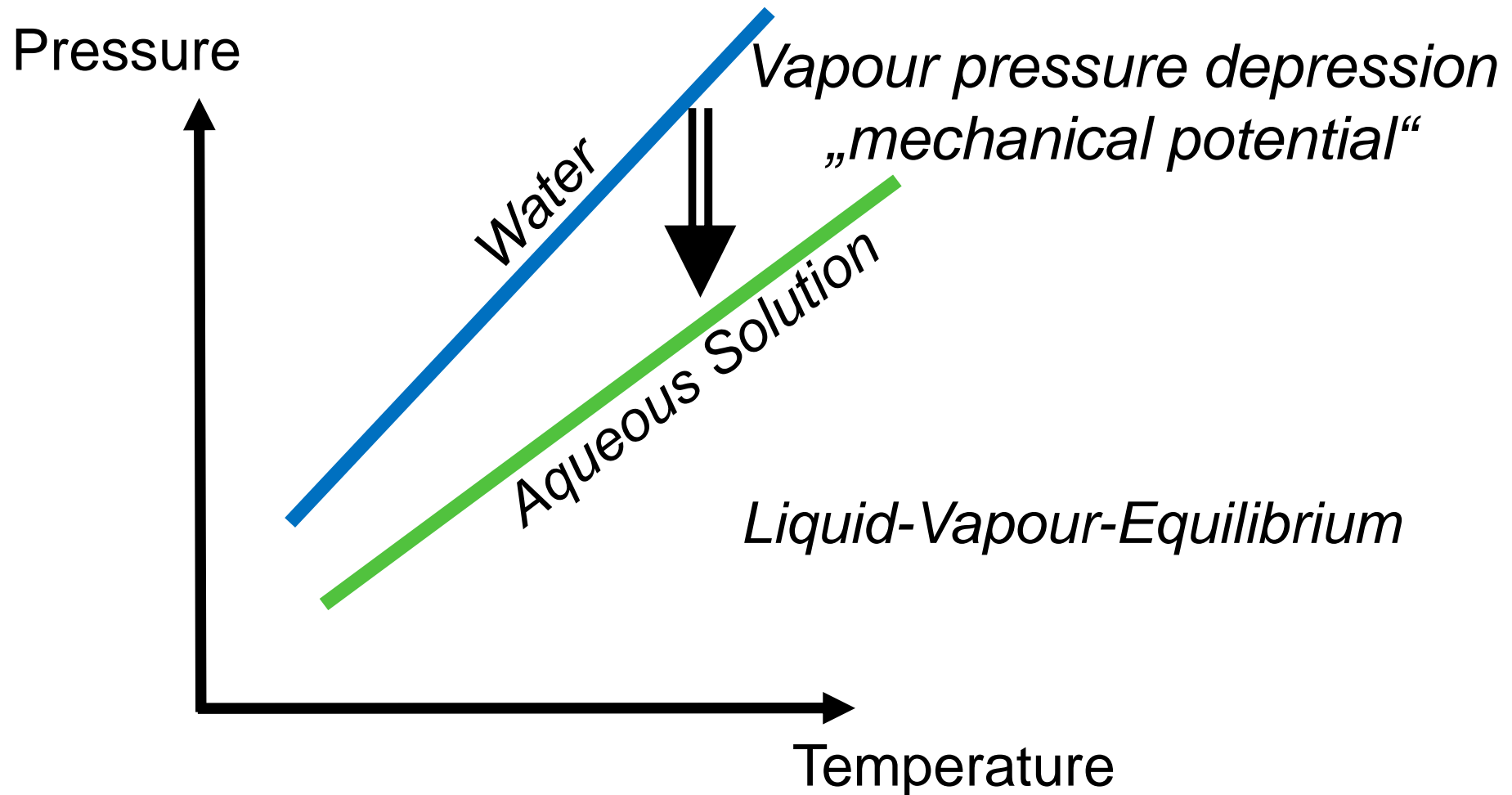

pressure

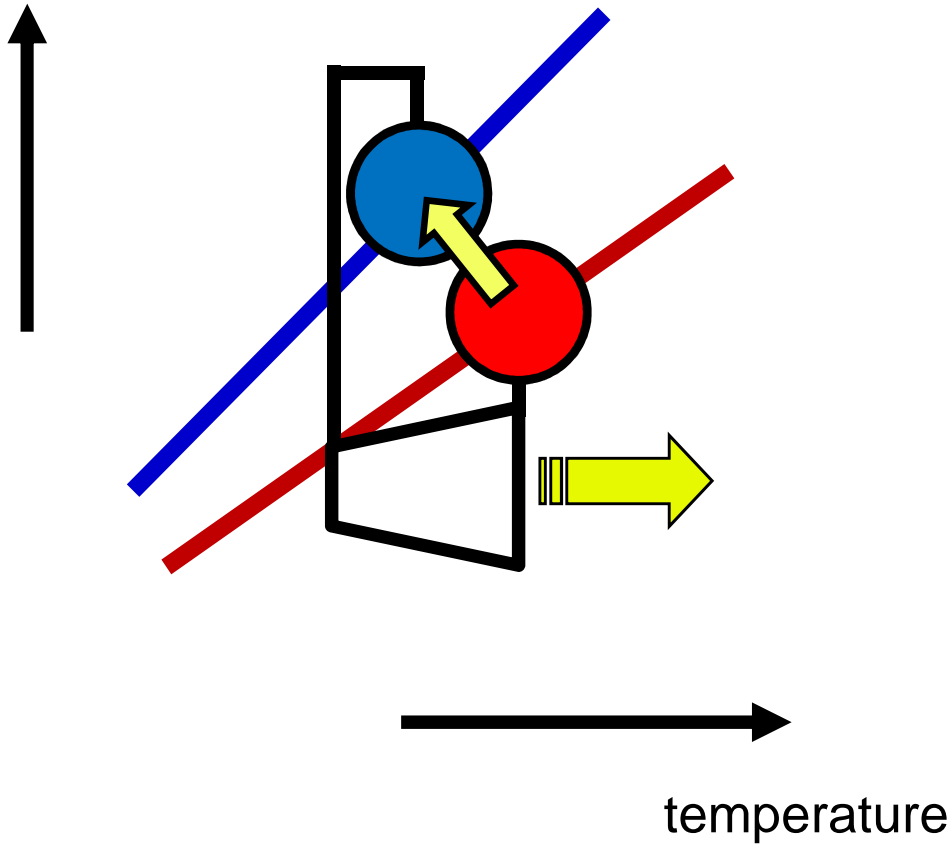

Discharging (work!)

pressure

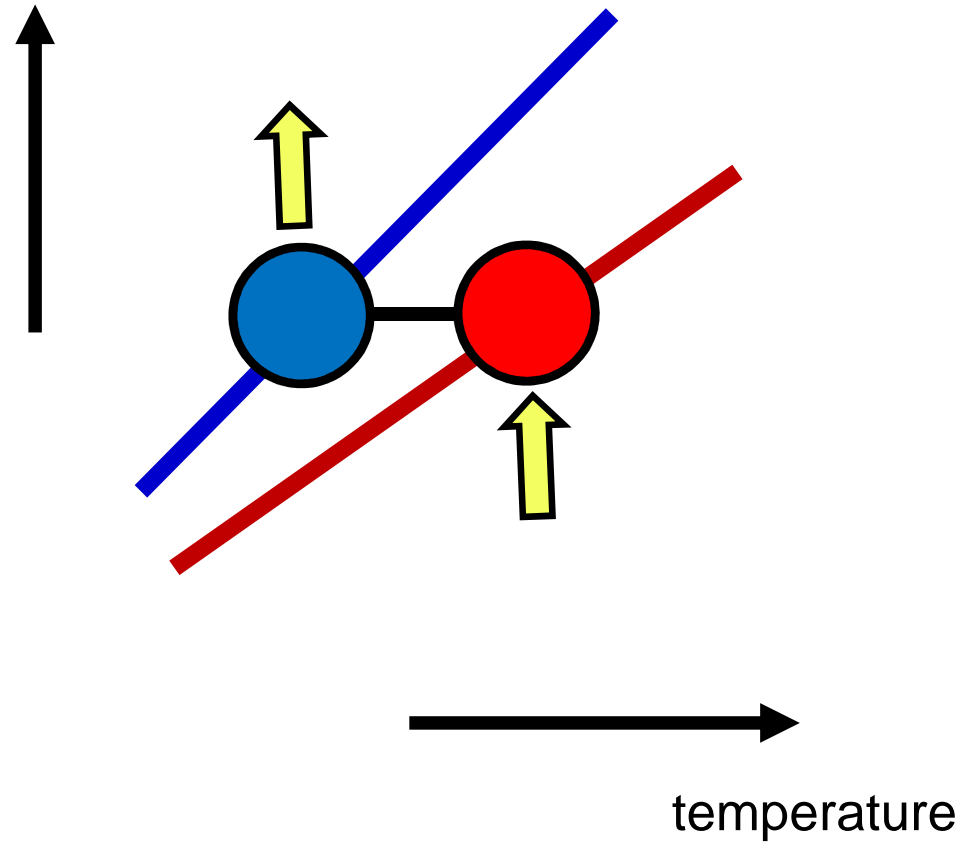

Charging (Heat!)

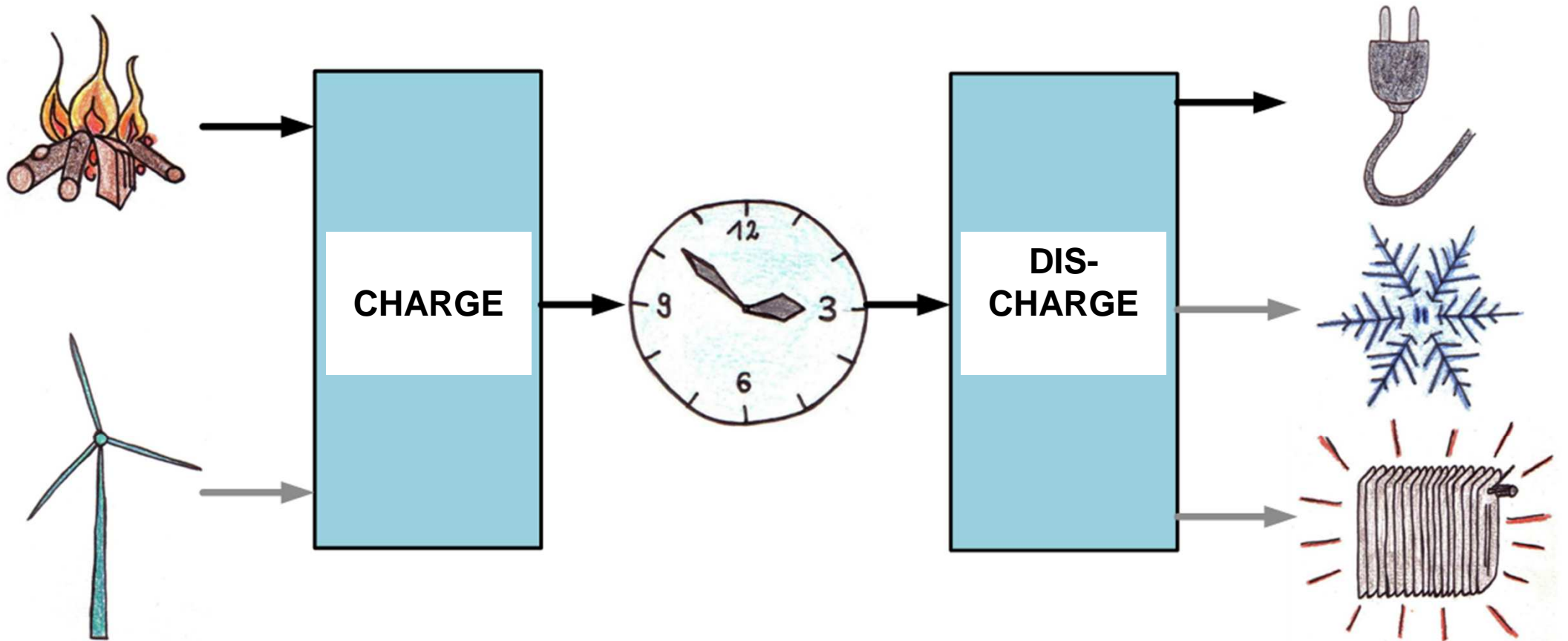

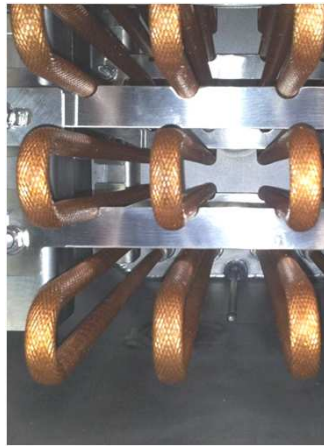
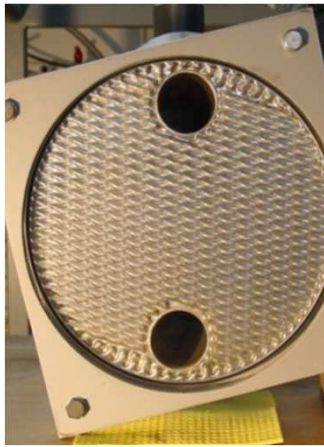

1. Tailor isotherms.
2. Improve heat and mass transfer.
3. Do not let heat flows stay unused.