



**Yves Hermier**

**Responsable du pôle « Métrologie Thermique »**



Groupe thématique « Hautes températures »

Le 29 juin 2010

# Organisation

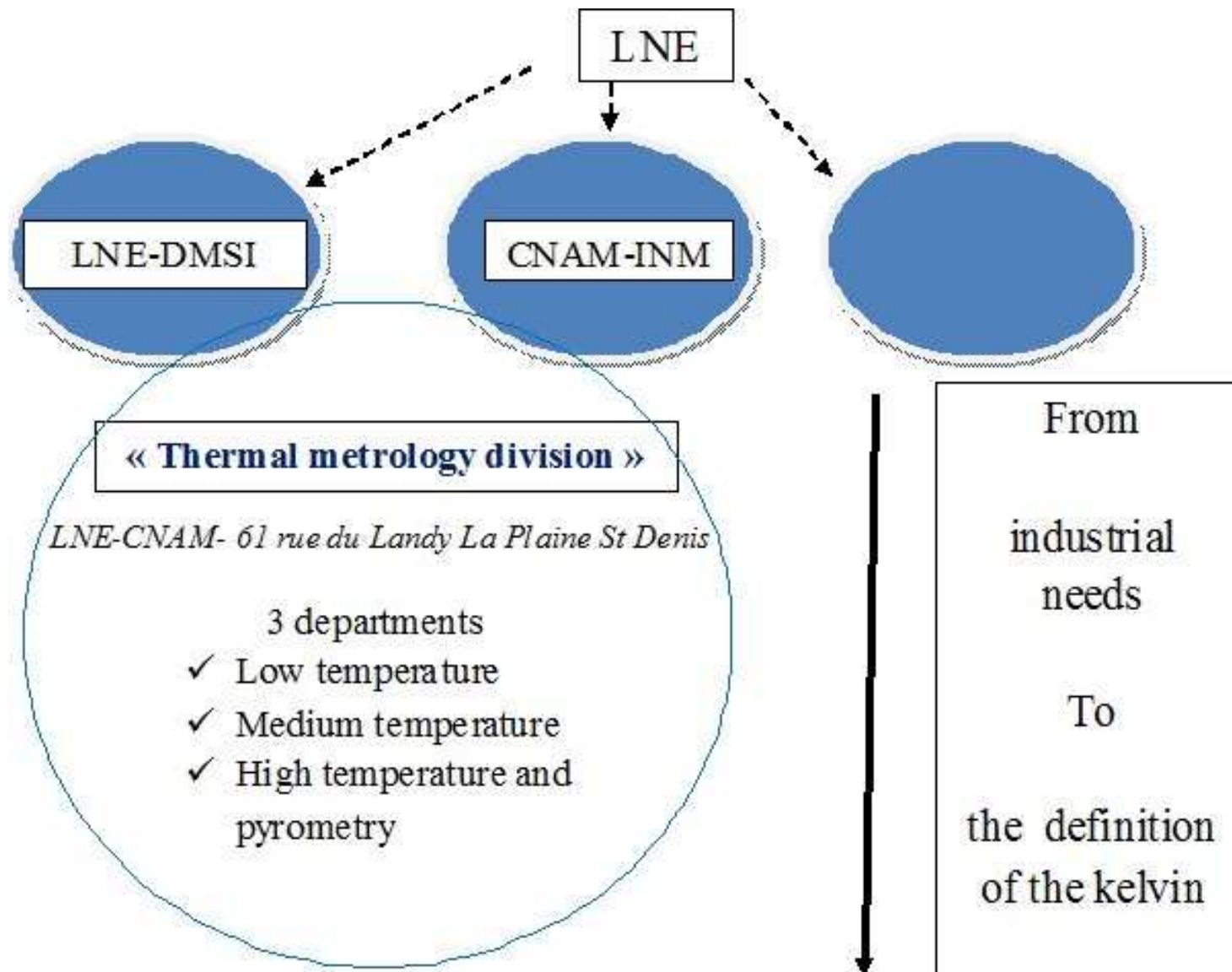

# The benefits

A new structure to build a stronger bridge  
between the research activities and the user (and not only industrial) needs

## Research and Development activity:

To prepare the calibration benches for “tomorrow”

To answer specific requests in the frame of national or international programs.

## Calibrations:

From the highest level (MRA- Mutual Recognition Arrangement), to different levels of uncertainty (COFRAC accreditation)

On a wide range of temperature, from a few millikelvins above the absolute zéro up to 3000°C (contact thermometry and pyrometry).

## Training and expertise:

For technical needs

For organization needs (Quality systems)

## Some new needs ??

- ✓ research purposes at low temperatures (below 1K) considering the fact that CNRS (French national centre for research) is now sensitive to the metrological aspects,
  - ✓ characterized and calibrated sensors below 10 K for space and superconductive magnets applications,
    - ✓ characterized and calibrated thermocouples up to 2000°C, especially for nuclear power plants applications,
      - ✓ characterized and calibrated radiation sources for pyrometers up to 3000°C.

***And some of these needs are at this time condensing through “European Program Calls” as recently through the “Energy”, “industry” and “environment” Calls.***

# LNE works on the whole temperature range (almost !!!)

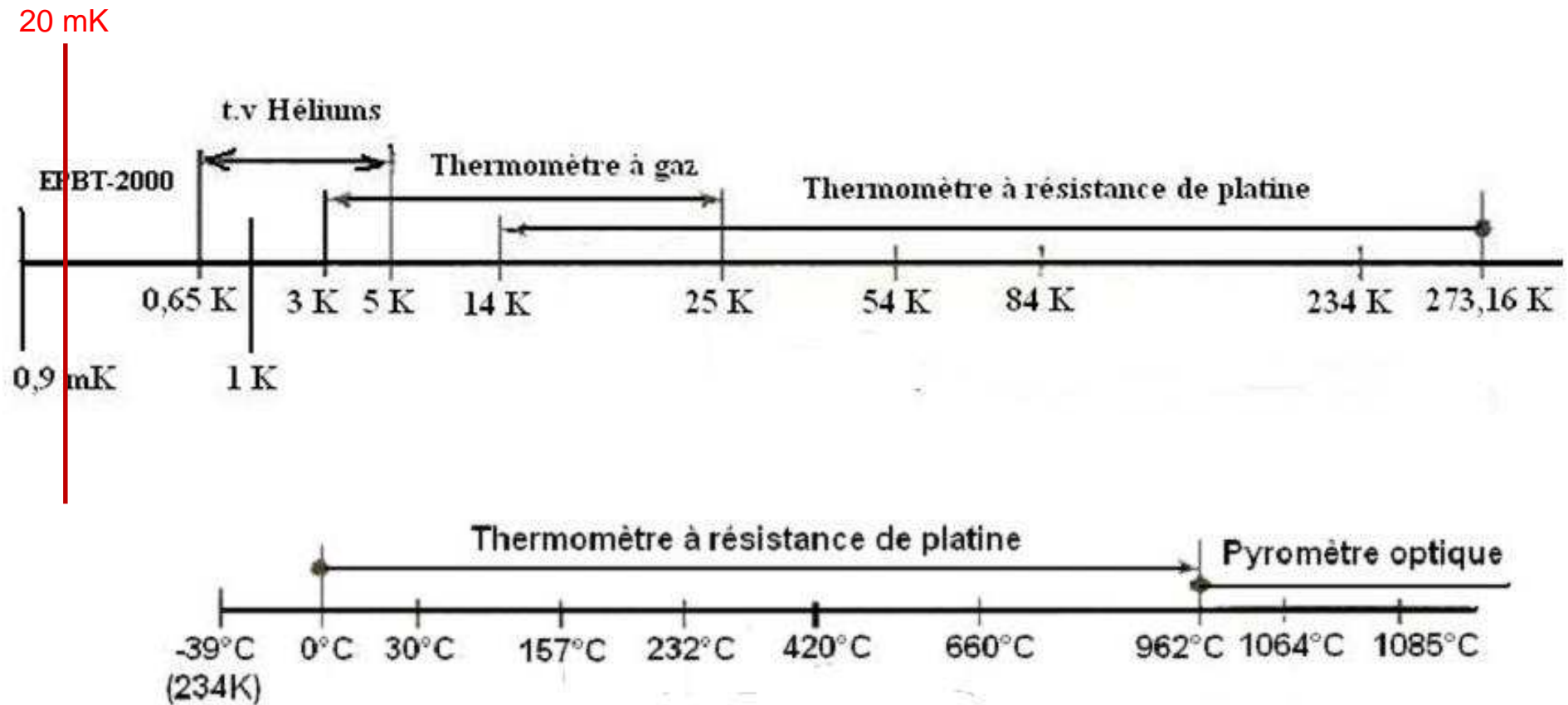

# The answers from LNE – at high temperatures

At high temperatures, calibration possibilities using eutectics fixed points

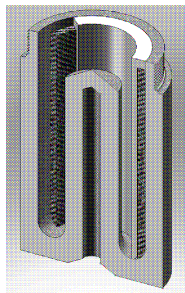

for pyrometry

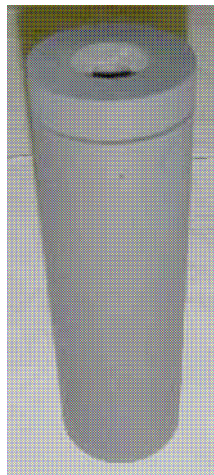

and for contact thermometry

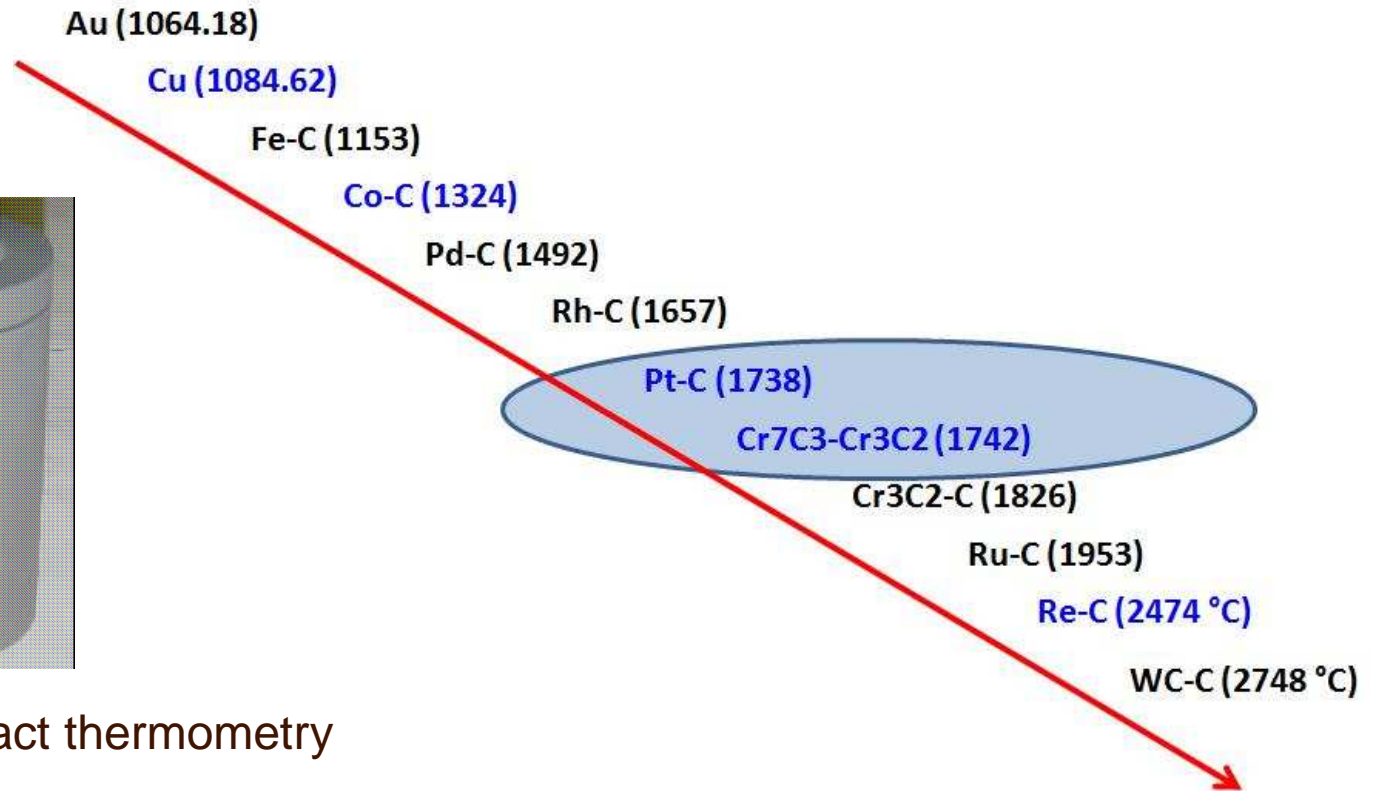

In blue the eutectics chosen by LNE to be developed.

# The answers from LNE – in the “medium temperature range”

Construction of all the fixed point cells (INM type) from argon up to silver point (except water)

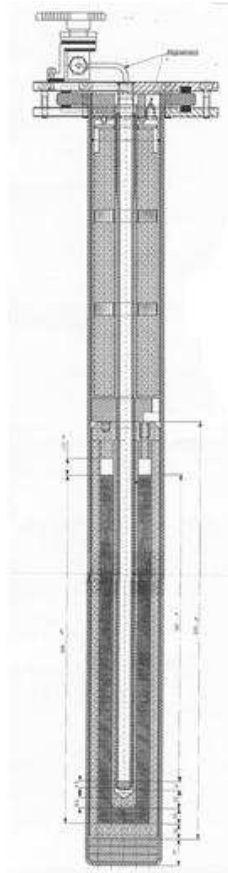
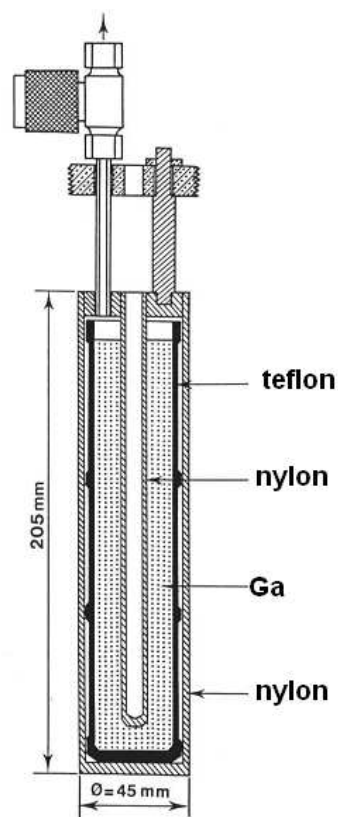

And in most cases the associated calorimeter

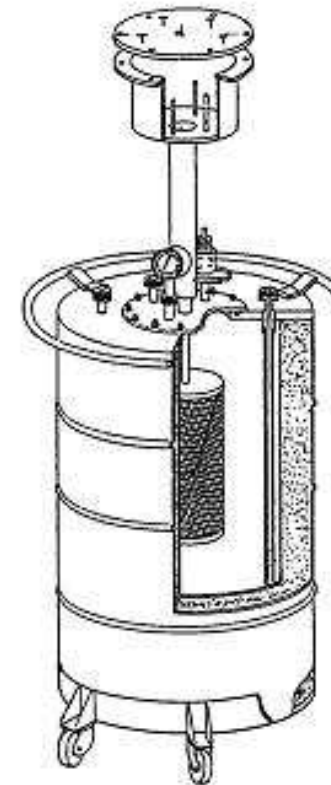

# The answers from LNE – in the “medium temperature range”

Construction of a “temperature amplifier”

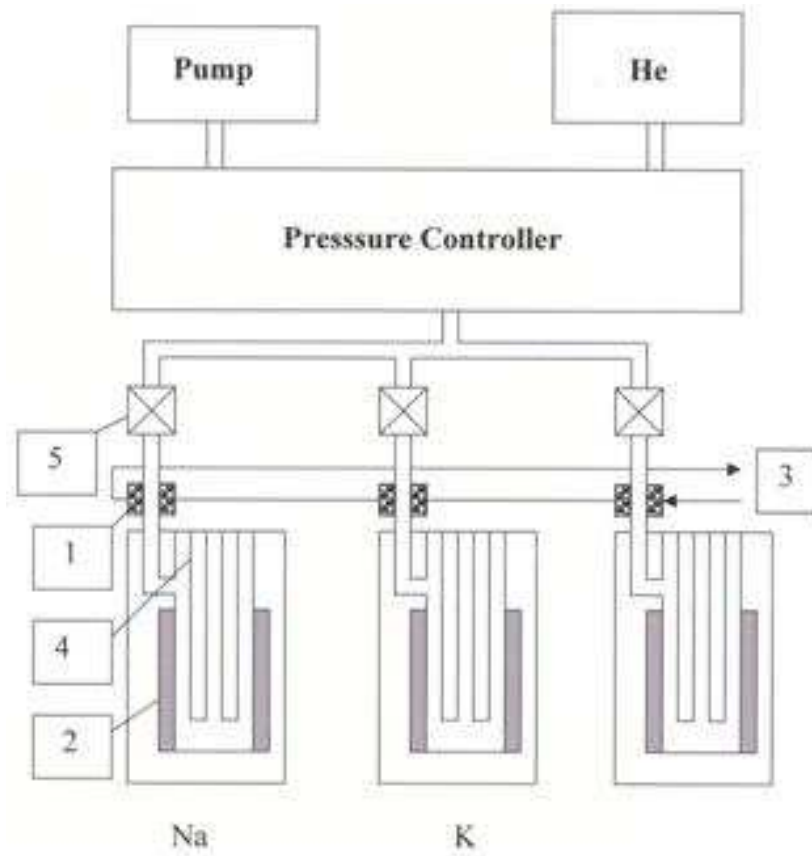



# The answers from LNE – in the “cryogenic range down to 14K”

“The multicells” and the calorimeter using a cryogenerator

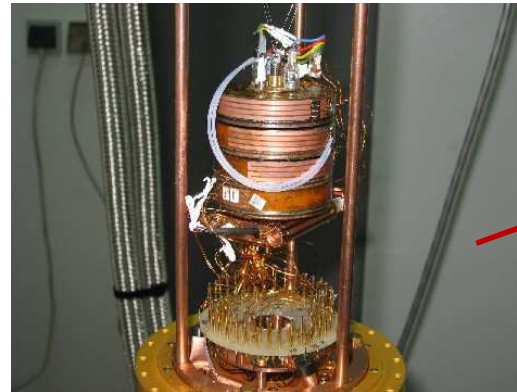
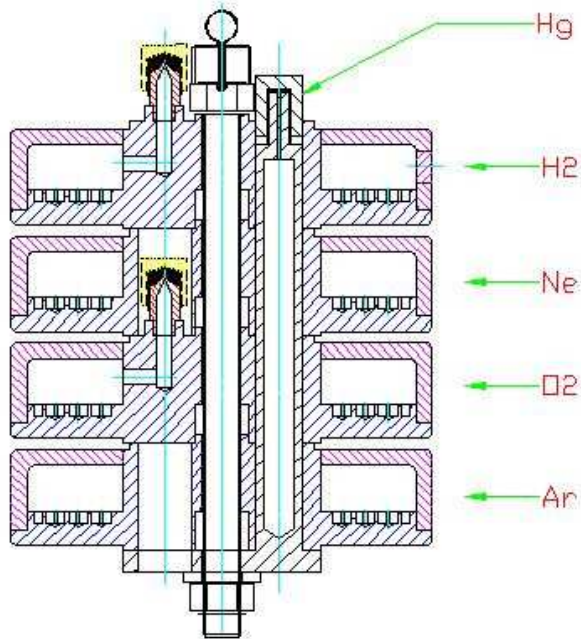

# The answers from LNE – in the 0,65K – 14K temperature range

The acoustic thermometer

$$\frac{T}{273K} \equiv \lim_{p \rightarrow 0} \frac{U^2(T, p)}{U^2(T_W, p)}$$

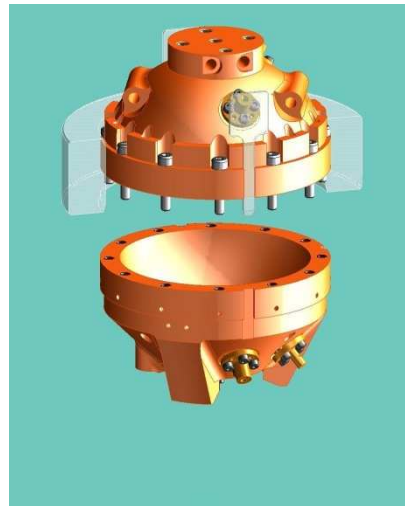

...and the helium-vapour thermometers

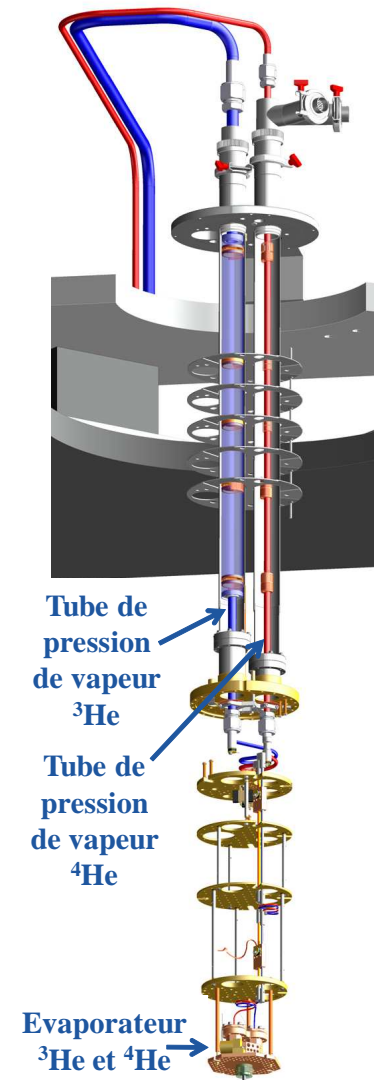

# The answers from LNE – below 1K



The (helium-3) melting curve thermometer realizing the PLTS-2000

And the SS (second-sound) thermometer as a transfer standard



# Is T90 wrong ?

LNE develops « primary » (thermodynamic) instruments in order to measure T and T-T90



Acoustic way

600°C ?

Radiometry way

Monochromatic source  
700 to 900 nm  
IR+UV

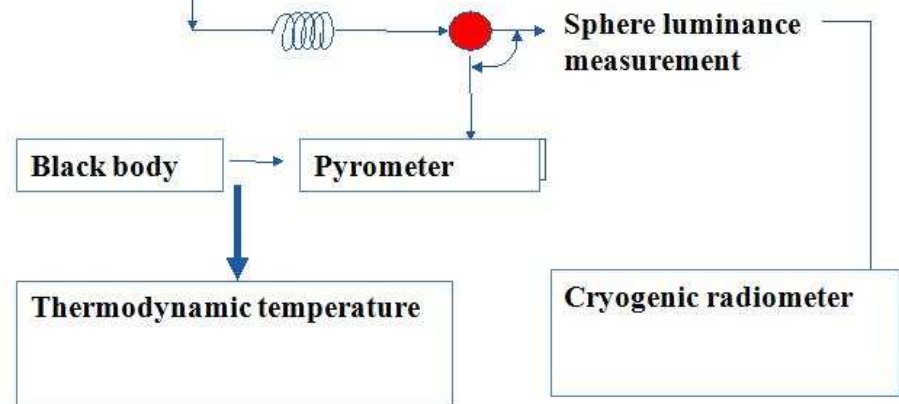

# Is T90 wrong ? Some results

Deviation T-T90 measured with the acoustic thermometer

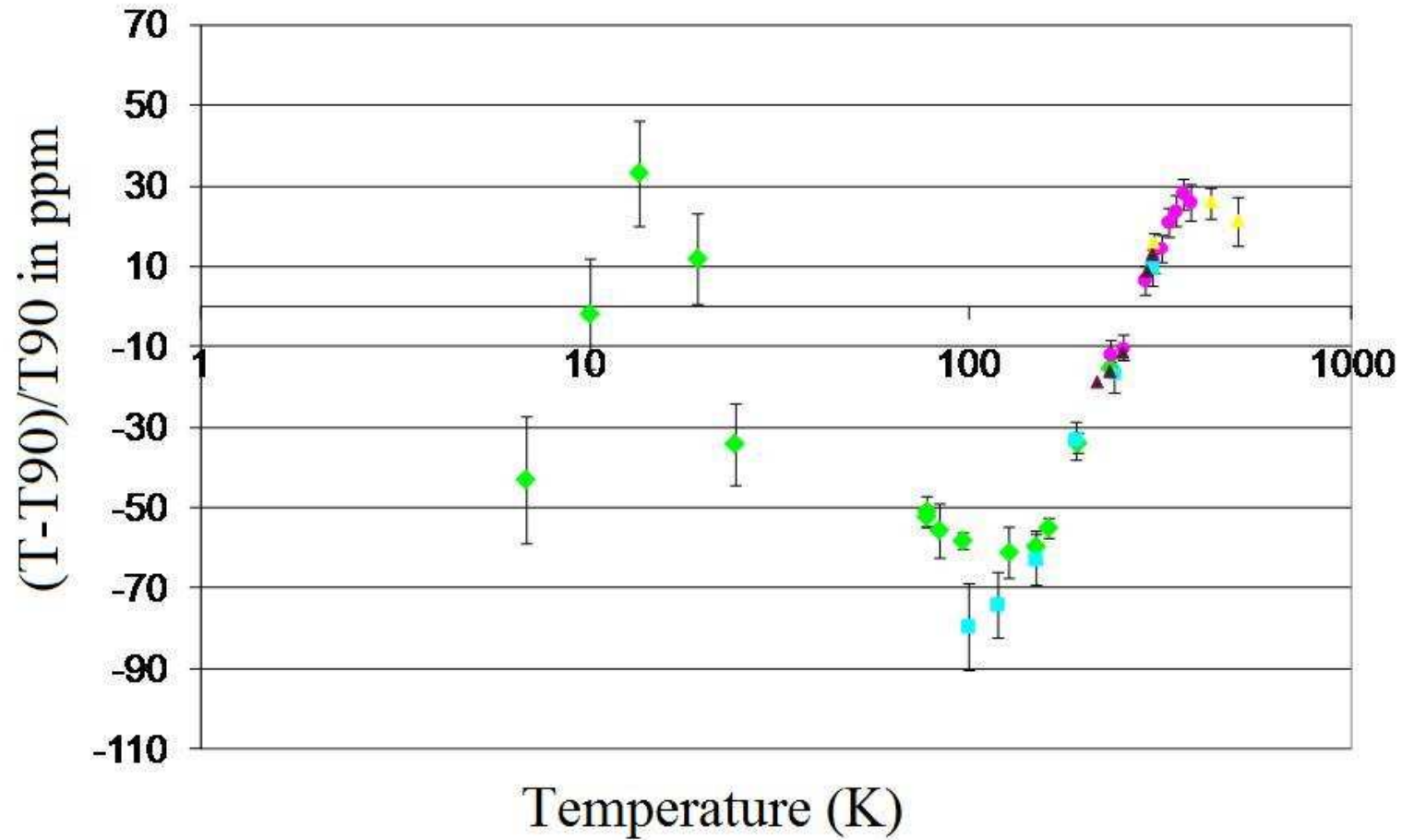

# And for measuring T ? Temperature unit ?

Two experiments at LNE for a new determination of the Boltzmann constant with as a target a relative uncertainty below 1 ppm

The acoustic way ....

SPHERE BCU4

CONCEPTION DU CRYOSTAT

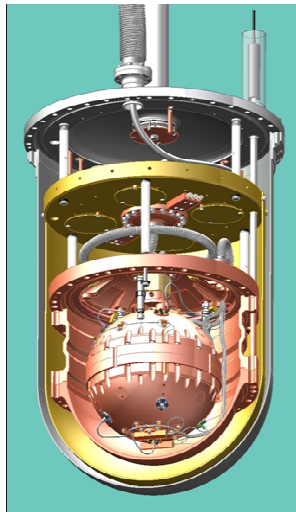
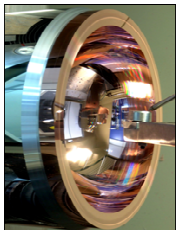
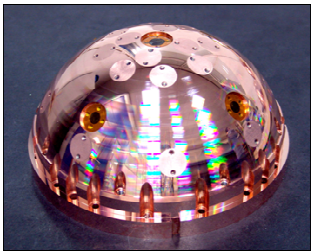

$$k = \left\langle \frac{3}{5} \frac{mc_0^2}{T_{tp,eau}} \left( \frac{Z_{nl}^{EM}}{Z_{nl}^A} \right)^2 \lim_{p \rightarrow 0} \left( \frac{\langle f_{nl}^A + \Delta f_{nl}^A \rangle}{\langle f_{nl}^{EM} + \Delta f_{nl}^{EM} \rangle} \right)^2 \right\rangle$$

$(k_B \text{ mes} - k_B \text{ codata})/k_B \text{ codata}$  ppm

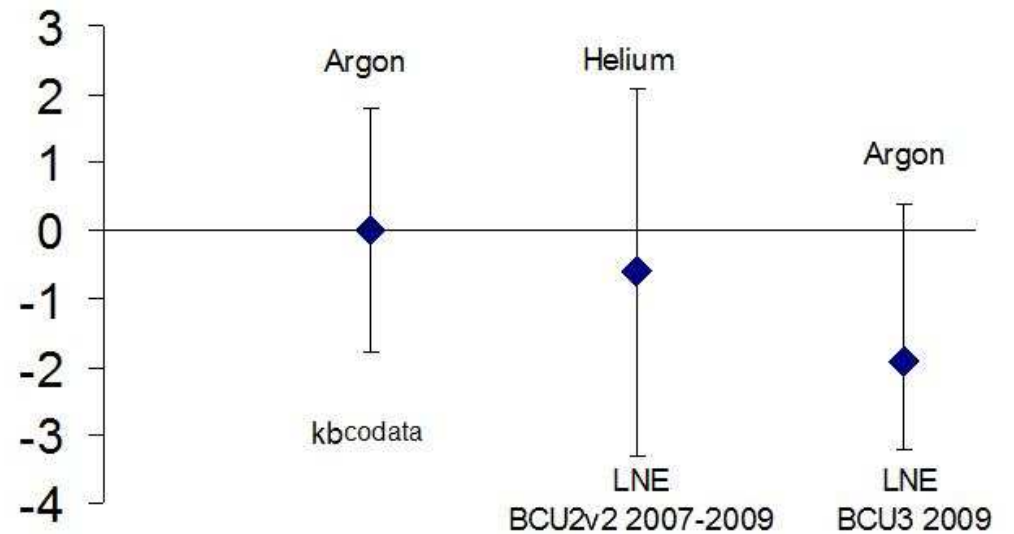

Near the WTP temperature

# And for measuring T ? Temperature unit ?

... and the spectroscopic way (in cooperation with Paris North university -galileo institute)

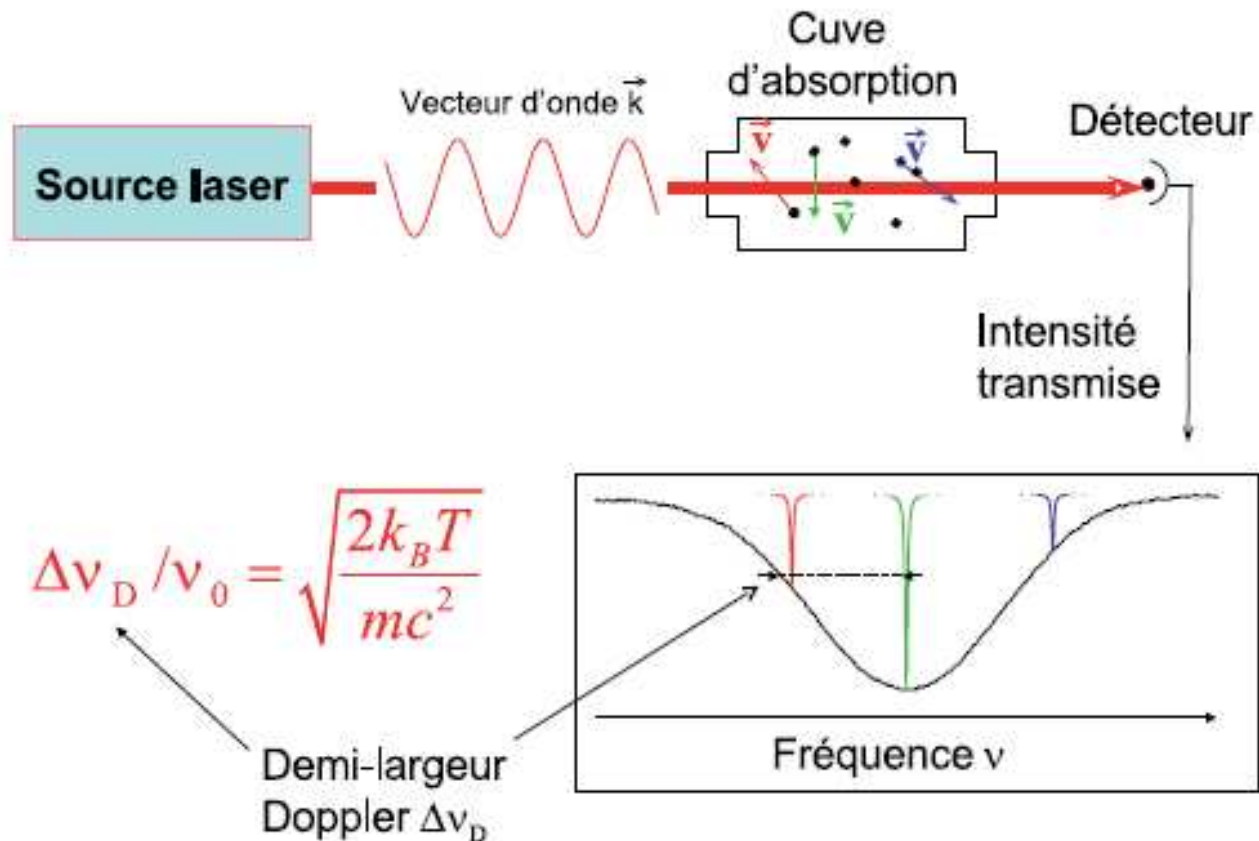

At the present time, a larger relative uncertainty (10 ppm) than for the acoustic way

# Conclusion

The “thermal metrology division” of LNE is putting in place all the references at any level of uncertainty in order to fulfill the actual and future needs of all kind of users.